

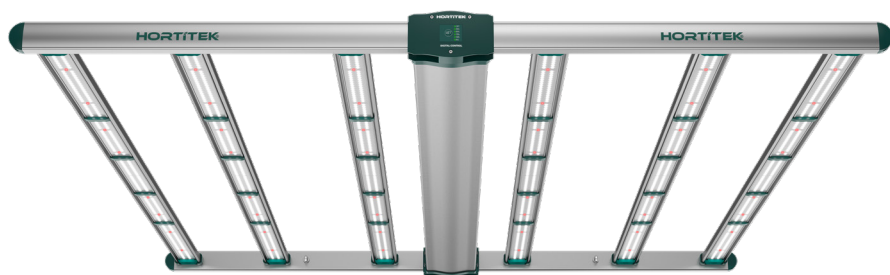





HORTITEK®
SIX BAR

INSTRUCTION MANUAL



PRODUCT SPECIFICATIONS

| | | |
|---------------------------|-------------|---|
| Product Code | | M4444 |
| Power | | 620W |
| Voltage Range / Frequency | | 100-277V ~ 50/60Hz |
| Current | Amp @ 120V: | 5.45A |
| | Amp @ 208V: | 3.0A |
| | Amp @ 220V: | 2.85A |
| | Amp @ 230V: | 2.75A |
| | Amp @ 240V: | 2.65A |
| | Amp @ 277V: | 2.30A |
| PPF Efficacy | | 2.5 μ mol/J |
| Max PPF | | 1550 μ mol/s |
| CCT | | 4000K |
| CRI | | 85% |
| PF | | >0.95 |
| THD | | <10% |
| Beam Angle | | 120° |
| Control Panel | | OFF / 25% / 50% / 75% / 100% / RC |
| External Control | | Compatible with 0-10V LED Controllers |
| Signal Cable | | 3.5mm TRS Male Jumper Cable |
| Thermal Management | | Passive |
| BTU/h | | 2116 |
| Protection | | Over-Voltage, Open Circuit, Short Circuit |
| Dimensions | | 1175x1172x67mm 46.3"x46.1"x2.6" |
| Weight | | 11kg \pm 0.3kg 24.2 \pm 0.66 lbs |
| Working Temperature | | 0°C to 40°C / 32°F to +104°F (95% RH) |
| Storage Temperature | | -40°C to 70°C / -40°F to +158°F (85% RH) |
| IP Rating | | IP65 |
| Warranty | | 3 Years |
| Certificates | |     |

COVERAGE AREA

| LIGHT COVERAGE AREA | | | |
|--|-------------|-------------|-------------|
| Application | Vegetative | Flower | |
| ¹ Hanging Height (cm) | 70 | 30 | 20 |
| Max PPFD ($\mu\text{mol/s/m}^2$) | 500 | 850 | 1000 |
| Coverage Dimensions (m) | 1.88 X 2.02 | 1.30 X 1.50 | 1.25 X 1.45 |
| ² Coverage Area (m ²) | 3.80 | 1.95 | 1.82 |

¹Hanging Height refers to the distance between the plant canopy and the LED.

²Coverage Area refers to the region that the plants receive at minimum 200PPFD for Flowering and 100PPFD for Vegetative.

DIMENSIONS (mm/inch)

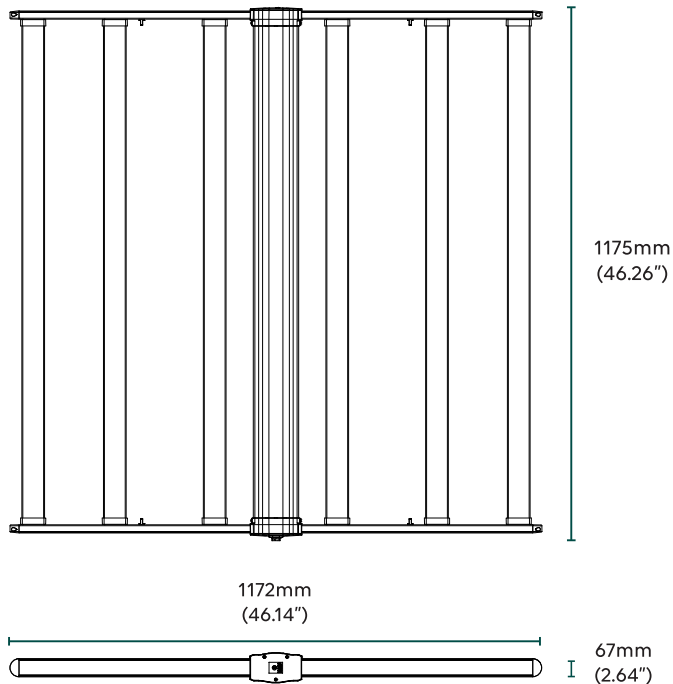

INSTALLATION INSTRUCTIONS

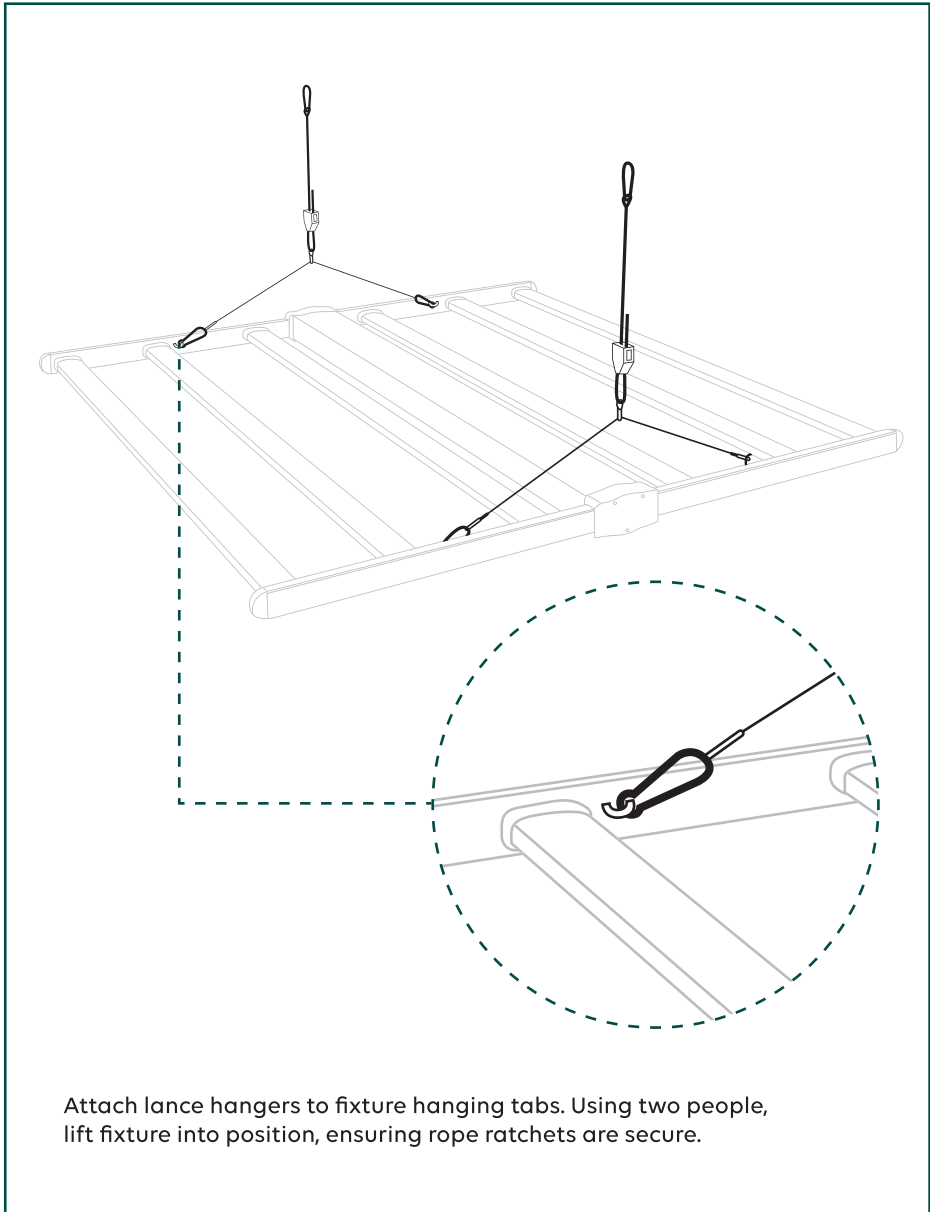

OPERATION INSTRUCTIONS

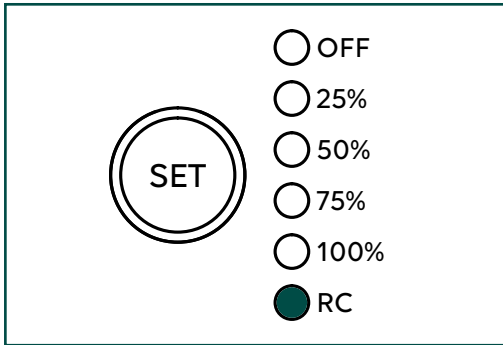

POWERING ON

Connect the SIX BAR to the power outlet using the AC Input Supply cable and power ON the fixture.

DIGITAL CONTROL

The SIX BAR features a 'Digital Control' that can switch between Power Dimming and Remote Control (RC) settings using the 'SET' button.

CONNECTING MULTIPLE LED FIXTURES

Connect the 3.5mm Male Jumper Cable between the Controller and the first 'IN' port on the SIX BAR.

To connect multiple SIX BAR's, continue to add Signal Cables between Fixture 'IN' & 'OUT' ports. Once connections are made, set the 'DIGITAL CONTROL' to 'RC' mode on all SIX BAR's.

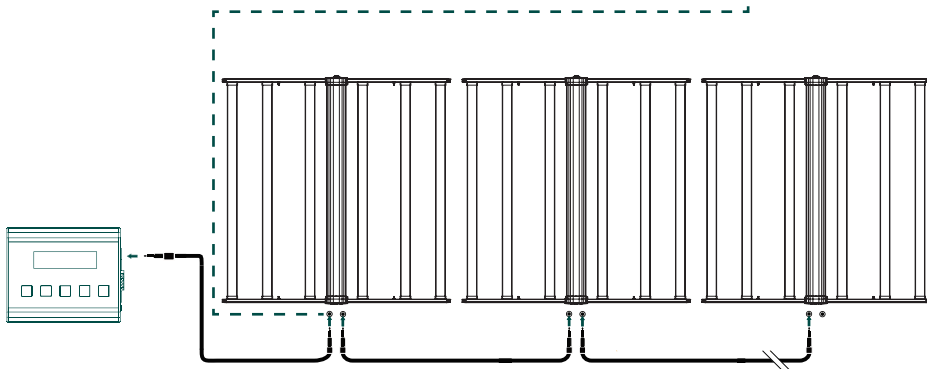
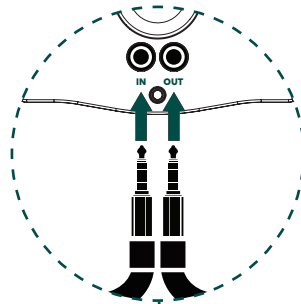

WARRANTY - CONTACT YOUR RETAILER FOR WARRANTY CLAIMS AND SUPPORT

The company guarantees the mechanical and electronic components of this product. It ensures the materials and workmanship is free of defects, used under normal operating conditions.

If there are any defects with this product that relate to the workmanship or the materials used, the company shall, at its discretion, either replace or repair the product.

However, improper use is NOT covered by warranty. This includes but is not limited to, overloading, user error, physical or water damage.

Warranty is valid for a period of three years from the original date of purchase.

SAFETY NOTES

Ensure that there is no visible damage before installing or using this product.

Keep away from hot objects and open flames.

Avoid touching during operation.

Ensure that selected power supply is switched OFF during installation.

Do not install underwater or in water soaked areas.

Do not use if power cable is damaged.

Do not attempt to service or replace LEDs yourself.



HORTITEK®

hortitek.com

