

 ATHENA®

# HANDBOOK



METRIC - EN







**For The Culture™**



The Athena® program was created out of the need for cultivators to have data-driven, easy-to-use, cannabis specific products that drive success, whether for one light or a thousand.

Our mission is to combat misinformation and share genuine knowledge, processes, and data based on observations in our grow rooms.

**ATHENA® IS NOT  
A NUTRIENT LINE,  
IT IS A PROGRAM.**

# TABLE OF CONTENTS

## 01 RESEARCH & DEVELOPMENT

## 08 SUPPORT

## 10 GROWER FEATURES

## 22 DRY SOLUBLE FERTILIZERS

PRO ★

Pro Feed Schedules.....	24
Pro Concentrate Mixing.....	26
Pro Dosatron Setup.....	28
Pro Dosage Reference Guide.....	31
Pro Irrigation Strategy.....	32
Pro Hand Watering Strategy.....	42
Checking Runoff.....	44
Pro Recipe Phases.....	48
Clones.....	48
Mothers & Veg.....	49
Flower.....	50
Finish.....	51
Pro Cup Winners.....	52

## 56 LIQUID FERTILIZERS

BLENDED 💧

Blended Feed Schedule.....	58
Blended Dosatron Setup.....	59
Blended Hand Watering Strategy.....	60
Blended Recipes.....	62
Clones.....	62
Mothers & Veg.....	63
Blended Cup Winners.....	64

## 66 WATER CONDITIONERS

PRO ★

BLENDED 💧

Balance Application Rate.....	68
Pro Balance Concentrate.....	69

## 70 CROP PROTECTION

IPW 🌿

FOLIAR 🌿

Tank Mix Spray.....	72
Leaf Cleaner.....	73

## 76 CLEANING & SANITIZATION

CLEAN ✦

Room & Surface Cleaning.....	78
Irrigation Line Cleaning.....	79

## 80 PROPAGATION

CULTURE ✦

VPDome Procedure.....	82
Cloning Step-By-Step.....	84

## 102 GENETIC PRESERVATION

CULTURE ✦

Tissue Culture Kit.....	105
Tissue Culture Procedures.....	106
Step 1: Media Prep.....	106
Step 2: Plant Prep.....	107
Step 3: Lab Prep.....	108
Step 4: Transfer.....	109

## 110 RECOMMENDATIONS

FACILITY ✕

Lighting Environment.....	110
HPS Layout.....	112
LED Layout.....	113
Climate.....	114
Drip Irrigation.....	116
Plant Spacing & Irrigation.....	117
EC to PPM Conversion.....	118

## 120 DEMETER DESIGNS

## 125 CONTACT INFORMATION

# RESEARCH & DEVELOPMENT





# CHRIS DURAND

*Director of Greenhouse  
Research Operations  
UC DAVIS 2004-2021*

At Athena® we pride ourselves in the knowledgeable and passionate team that we have in-house, working day after day to bring the best cannabis nutrients, supplies, and solutions to the market. One key member of that team is our Director of Manufacturing, Chris Durand.

Chris grew up around agriculture and knew that was where he wanted his career path to lead. He attended UC Davis in California, working in greenhouses running bug trials and developing fertilizer programs for the plants that they were growing. His passion for formulation started when he was working for the department of entomology at UC Davis where he was formulating small batches of fertilizer for Cannabis

that he was growing on his own. His experience and passion for the plant led to his role on campus in becoming the Director of Greenhouse Research Operations for 15 years. During these vital years, Chris worked on over 400 different projects ranging from yield trials, to genetic expression and eventually developing the Athena® Blended Line.

With Chris on the forefront of manufacturing and now heading up the R&D department, Athena® has excelled at bringing some of the cleanest most consistent fertilizers to the cannabis market; Pro Line and Blended Line.



Our commitment to R&D has enabled us to develop innovative and unique products that meet the needs of our customers. We invest millions of dollars in R&D, and we partner with renowned experts in the industry, such as **Dr. Bruce Bugbee at Utah State University & Chris Durand, former Director of Greenhouse Operations at UC Davis**, to ensure that we remain at the forefront of the industry. Bringing plant science and continuous testing together with incredible cultivators has been our recipe for success.

Our R&D process is rigorous and extensive. We have multiple R&D rooms based out of one of Jungle Boys' LA facilities, where we trial products side by side under different light sources with different mix ratios. We also conduct continuous testing to ensure that our products are of the highest quality and meet the needs of our customers. Our dedication to R&D has enabled us to develop our Pro and Blended lines, which have become household names in the industry.

We took our commitment to R&D to the next level in 2021. We invested even more time and money into R&D, testing countless products that didn't make it to market. However, our dedication paid off, and we were able to develop three products

**RESEARCH AND DEVELOPMENT (R&D)** is a critical component of Athena's success, and it is what sets us apart from our competitors.

that have become game-changers in the industry: the TC Kit, VPDome, and Fade. These products are a testament to our commitment to innovation and our determination to develop products that exceed our customers' expectations. We will continue to invest in R&D to ensure that we remain at the forefront of the industry and continue to develop products that set us apart.

In conclusion, R&D is at the heart of everything we do at Athena. It is what has enabled us to develop unique and innovative products that meet the needs of our customers. We are committed to never stop innovating. Innovation distinguishes a leader from a follower.



Athena® R&D team taking measurements of twelve data points and monitoring bud development.



**DR.  
BRUCE  
BUGBEE**

*Professor of Crop Physiology,  
Utah State*

**Dr. Bruce Bugbee** is an American scientist with a prestigious educational and research background with degrees from the University of Minnesota (Bachelor of Science), University of California, Davis (Master of Science), and Penn State University (Ph.D.). His work includes research into space farming with NASA to help develop regenerative life support systems. He and his students developed a dwarf variety of wheat that has been used in several studies on the Space Station, and he is currently working with NASA to study the use of fiber optics for growing plants in space.

After 34-years Dr, Bugbee is still located at Utah State University, where he is the Director of the Crop Physiology Laboratory. Athena® is proud to be partnering with him in our pursuit of commitment; to never stop innovating. Innovation distinguishes a leader from a follower. Partnering with Dr. Bruce Bugbee at Utah State University allows Athena® access to a team of research analysts running trials for various studies. Results to further develop better products and more consistent methods of cultivating **the plant we all love.**





  
**For The Culture™**

The Athena® Tissue Culture Kit was developed through extensive R&D at Jungle Boys state-of-the-art TC Lab in the heart of Los Angeles.

Developing the Tissue Culture Kit took many trials, months of collecting data and reassessing TC procedures. The Athena® x Jungle Boys team set out to develop a media gel for cannabis, but soon realized the average grower wouldn't have all of the necessary tools to use the media properly and to its full potential. And so the Tissue Culture Kit was born: a portable mini lab to go with the proprietary gels. The TC Kit ensures growers have the most success while also learning with professional grade tools. The portable flow hood featured in the kit is a game changer in so many ways. If you're already a pro, it can be used as a tool for portability, outsourced work, greenhouse work and more. If you're just getting

started, this revolutionary new tool has all the steps, tricks and tips built right in. Easy-to-follow standard operating procedures with visuals are printed on the inside of the lid and accessible step-by-step videos walk users of any experience level through the entire tissue culture process.

The TC Kit enables the next generation to enter our cannabis space at a higher level, and is a great starting point for the industry to evolve from. With increasing risks of pathogens and disease to crops, we recognize the benefit of everyone having the ability to manage a variety of disease free cultivars and protecting their genetic library.



## HOW DO YOU FADE?

Athena® developed Fade to improve the traditional flush. We've never been happy with the traditional 2 week flush and understood the potential for quality improvement, but the idea of removing all nutrients at the end of a run has always been a risky affair. Bud rot is a challenge to manage in the best conditions, and removing calcium for two weeks is like an invitation for botrytis to set in. The move to higher density and smaller roots zones has compounded the problem.

Simply put, we understood the quality improvements associated with a good flush, but were frustrated with the increased risk of bud rot from calcium deficiency. Solving this problem led to the development of Fade.

The initial stage of developing Fade focused on calcium management during flush. Maintaining adequate calcium levels during the final 2 weeks flush would theoretically reduce shoot tip necrosis and the incidence of botrytis and bud rot. This worked, but we thought we could do even better.

We decided to look beyond calcium and we thought about every element's impact on a plant during its last weeks. This led us to begin testing formulations that eliminated nitrogen and maintained all other critical elemental levels. This strategy ensured we didn't have any hidden deficiencies during the final weeks that could negatively impact yield. Initial trials confirmed that the shift in focus was exactly what we needed and Fade emerged in its final form as an easy to use Core replacement.

Intensive research and development were key in this outcome. Our first testing stage was in our small R&D rooms for proof of concept. Once satisfied we moved to large-scale side-by-side testing at the Jungle Boys facilities--multiple strains were tested over multiple cycles. We also utilized other testing partners for final validation. After evaluating all of the data it was conclusive that Fade with Pro Bloom during the last weeks of flower reliably increased terpene and total cannabinoid production without increasing the risk of deficiencies and bud rot.



Finishing with **Fade zero-nitrogen flush** removes chlorophyll from the plant leaves and flower.



Removal of chlorophyll from flower increases trichome, terpene and THC production.

Removing nitrogen purples or ambers leaf color.



## TECH TEAM

At Athena®, not only do we have a qualified team of advisors, but we also have the best in the game offering technical support via phone and through comments/DMs to our social media following through Instagram, Facebook, Youtube, LinkedIn and more. The tech support team is led up by Steve Huff and two other support technicians. Steve has over 30 years of experience in the cannabis industry and has managed over 30,000 sqft of canopy.

His areas of expertise are nutrient management, irrigation, and IPM SOPs. He worked the counter of a large Hydroponics retailer for 8 years where he guided and helped local growers become successful. Now he guides and helps growers nationwide and internationally. Our goal is to help growers become successful by giving advice based on generations of cultivation experience.

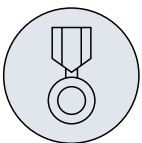

Experienced  
Growers



Procedure  
Training

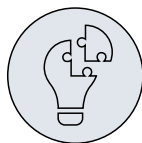

Troubleshoot  
Problems

Need help troubleshooting  
an issue in your grow?

**Contact our Tech Support**

**844-333-1818**

# FACILITY ADVISORS

The Perfect Run.™

We don't believe in charging for grow advice. Our in-house team and facility advisors are here to help growers at any scale. All facility advisors have run and managed large commercial facilities. These guys are all top-tier cultivators that continue training with the teams at Jungle Boys.

Facility Advisors specialize not only in the Athena® program, but also in solving various facility, irrigation, and environmental issues. The program's primary objective is to promote success across the cannabis industry. They have a fundamental belief that "if you don't do it, you don't know it." They possess firsthand knowledge and experience in irrigation strategy, EC stacking, IPM, irrigation automation, and facility standard operating procedures.

Commercial growers and licensed producers can take advantage of Athena's Facility Advisor program, which offers additional services at no extra cost. The team's expertise is a combination of years of knowledge and research and development. According to Brandon Burkhart, the founder of Athena®, "Our facility advisors learn from some of the best in the game to help guide facilities using the Athena® program out in the field."

Need hands-on  
facility support?

**Contact our  
Facility Advisors**

**844-333-1818 #4**

They are also more than willing to help growers of any scale diagnose problems and offer support through their social media channels.

To diagnose problems and optimize quality yields, the Facility Advisor team is equipped with kits containing instruments to measure PPFd/energy, water content, EC, substrate temperature in the medium, ORP, and other essential tools.



# MILE HIGH DAVE

David Crawford  
Mile High Dave Farms  
IG: @Milehighdave420  
Line: Pro Line  
Location: Colorado

## Living the Dream, Leaving A Legacy

Colorado cannabis cultivator and breeder Mile High Dave has been in the game for over 25 years, with a love for the plant dating back to his teenage years.

"I used to hide my High Times Magazine from my parents when I was a kid," he says. "Always dreaming of growing something magazine worthy."

At 22 years old, Dave hit hardship. While living in California, he was arrested and sent to prison for felony cultivation, setting him back for more than a decade.

Today, however, he says the same thing that took his freedom away has given him more freedom than he ever thought possible. Dave moved to CO just a few years before 2012 when cannabis became legal there. Dave was able to grow and smoke legally.

"I decided to stay for good because I was truly living the dream at the time," he says.

For Dave, the cannabis industry is where he can build to financial freedom and leave a historical legacy behind him.





“  
WHY LOOK TO  
THE NEXT MAN  
FOR GREATNESS  
WHEN YOU CAN LOOK  
WITHIN YOURSELF?”



Dave hunted his strain, **Dantes Inferno** (Oreoz x Devil Driver), for over 2 years to find the extremely popular keepers making rounds across the country. He says his ultimate goal is to supply major cultivation facilities across the country with exclusive genetics like **Dantes Inferno**.

As a cultivator and breeder, Dave wants to bring the most unique and highest quality cannabis he can find to the masses. To achieve this he relies on Athena®.

“I've used many different nutrients over the years, from mixing my own organic soils to many different salt-based brands. Athena by far has the best nutrients I've ever used,” he says. “When it comes to overall results and cost vs results Athena can't be topped by any other nutrients I've used, whether organic or synthetic”





## GHOSTBUDSTERS FARM

Chris & Brandon  
Ghostbudsters Farm  
**IG:** @Ghostbudstersfarm  
**Line:** Pro Line  
**Location:** Michigan

Chris (@ghostbudstersfarm) and his business partner, Brandon, started growing together in Hamtramck and Detroit in 2008, shortly after voters passed the Michigan Medical Marijuana Act. With passion for the plant, an unstoppable drive and dedication to an industry that helps people, Ghostbudsters Farm was built from the ground up. Fifteen years and many ups and downs later, they now have a growing following, have won

several High Times Cannabis Cup awards and are sold in hundreds of stores throughout the state.

Ghostbudsters Farm says they remained dedicated to growing the brand and expanding their plant and cultivation knowledge to rise to where they are today. After recently establishing a 300-light cultivation facility with no investors, they say they're in talks with out-of-state operators and their future holds endless opportunities.

Chris credits Athena for a big difference in day-to-day operations. After using almost every nutrient company on the market, he says nothing seemed to click until they came across Athena.

“ (ATHENA®) IS INCREDIBLY EASY TO USE AND HAS GIVEN US BETTER RESULTS THAN ANY OTHER NUTRIENT ON THE MARKET. NOT ONLY IS IT THE BEST NUTRIENT LINE AROUND, I’VE MET A GROUP OF FRIENDS THAT HAVE BECOME FAMILY, ”  
– SAYS CHRIS



“I WILL ONLY USE WHAT WORKS BEST IN OUR GARDEN AND THAT IS ATHENA®.”



# BIGBANG CREATIONS

Jay - BigBang Creations  
 IG: @bigbangcreations\_  
 Location: Spain

Bigbang Creations was built on passion and dedication to research and quality. Co-Founder Jay developed an interest in cannabis at the age of 13, after his father passed away from Cancer. The girl he was dating at the time owned a grow shop. After learning its medical benefits and uses from magazines, Jay quickly became obsessed with cannabis and its culture and began popping seeds here and there. It wasn't until the Spanish social club scene started flourishing that growing became more serious for Jay. He says with his business partner's extensive knowledge, their hours of research on US growing techniques, and discovering the Jungle Boys and Athena's procedures – Bigbang Creations was born.



Bigbang Creations has won various important awards in Spain. They are proud to deliver the best they can to patients and consumers, enduring quality despite being in an unregulated market. The consistency Bigbang Creations achieved by switching to the Athena® Pro Line was unparalleled to anything they had worked with before. Jay says being HPS growers originally, making a swift switch to LED and growing with Rockwool/Drip feed would have been impossible without all the knowledge Athena offers online for free.



**“ THE VALUES WE STAND BY ARE SIMPLE; TO DO OUR BEST IN EVERY STEP OF THE PROCESS, TO DELIVER SOMETHING WE CAN BE PROUD OF. ”**

“The values we stand by are simple; to do our best in every step of the process, to deliver something we can be proud of,” Jay says. “We don’t like to cut corners or sacrifice quality. Straight after the first run, we realized what a game changer Athena was. We are proud of our work and proud of using Athena.”

Despite confusing laws surrounding cultivation in Spain, Bigbang Creations remains dedicated to increasing their knowledge and scaling up to bigger projects once clearer laws come in the future.



# Jungle Boys

## ROACH from Jungle Boys

IG: @waxfaced

Location: Los Angeles

**Athena's relationship** with the Jungle Boys team extends to one of their key members Roach. Roach started off in the industry as a budtender in Long Beach, California around 2012. Several years later he met Ivan while vending concentrates in LA and living in Mammoth Lakes. They kept in touch and a short few months later he was asked to move to LA and work at TLC Collective in packaging; trapping hard. Within a year of being there he moved into the Jungle and started working 7 days a week for months at a time to learn as much about growing cannabis as possible.

Roach now manages Jungle Boys operations throughout Los Angeles and Florida. He is passionate about this path and looks forward to continuing to manage and advance in operations to grow fire cannabis with the best team in the

industry. "The cannabis industry is everything. Without it, a lot of people would not have jobs or access to high quality medicine. I can't imagine being in a better industry."

Athena's honored to have been able to work so closely with Roach on implementing the Athena® program throughout all Jungle Boys facilities. He has given vital feedback and helped adjust the program after many trials throughout their operation. *"Using Athena since its inception has been an amazing overall experience. We have worked together to adapt feed programs and find what works best as a baseline for all growers of any scale. It's what we use in 100% of our gardens."*



ngle  
ays



“ THE  
**CANNABIS  
INDUSTRY**

IS EVERYTHING.

WITHOUT IT, A LOT OF  
PEOPLE WOULD NOT  
HAVE JOBS OR ACCESS  
TO HIGH QUALITY  
MEDICINE. I CAN'T  
IMAGINE BEING IN A  
BETTER INDUSTRY.”

**ATHENA**

Lance  
Craft Farmer  
IG: @Craft\_Farmer  
Line: Pro Line  
Location: California



# CUT THE F#\$%IN' CHECK

Lance, also known as Craft Farmer, was born and raised deep in the Redwood Jungle of Mendocino County. He became infatuated with cannabis at an early age of 18 and made it his life work moving forward. Now with 20 years under his belt, he is making waves. Nothing has been able to break his symbiotic relationship he has with the plant. Through robberies, catching cases, shootings, and asset forfeiture it never deterred Lance from his quest. "I always pushed forward regardless of what happened to me or the hand that was dealt. I knew deep in my heart this is what I was meant to do, and NOTHING was going to stop me."

Fast forward to today, Craft Farmer is cultivating in multiple states, he has an education channel teaching people to be better cultivators, and has designed and made products like Undercanopy lights that are giving HUGE returns. "Getting connected with Athena® and using their products gave me the confidence to really expand and help other cultivators across the world. I know when I'm helping someone, or giving them a recipe we can count on Athena Ag nutrients. The relationships I have created through Athena Ag have been priceless."



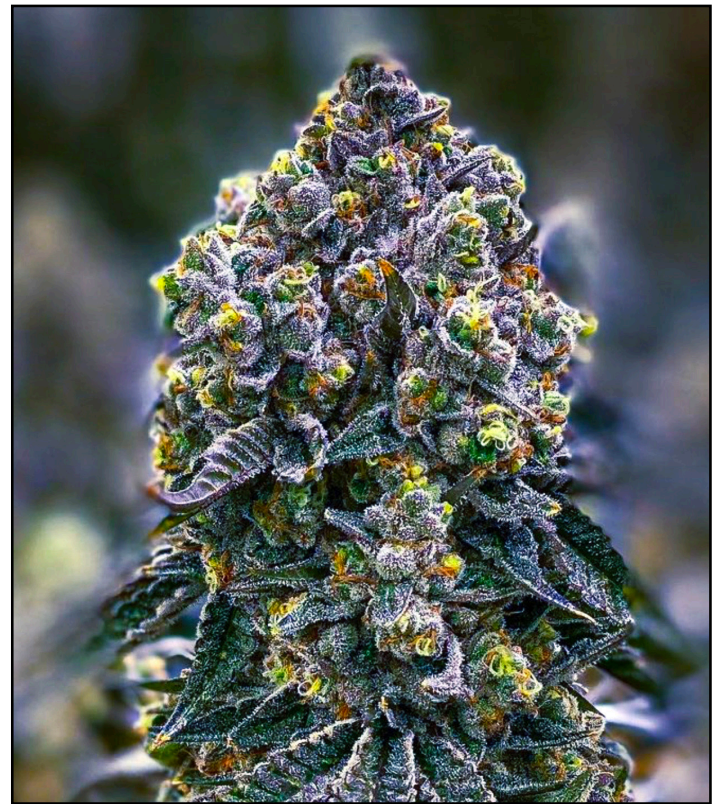

“ GETTING CONNECTED WITH ATHENA® AND USING THEIR PRODUCTS GAVE ME THE CONFIDENCE TO REALLY EXPAND AND HELP OTHER CULTIVATORS ACROSS THE WORLD. ”





## NANTO LABZ

IG: @nanto\_labz

Location: United Kingdom

**The hustle** has always been a way of life for the UK-based Nanto Labz team. From auto-flowering seeds under 250 HPS lights at a young age to large-scale grows, the team has remained obsessed and dedicated to cannabis cultivation. Nanto Labz grows are built on dedication to detail, organization, flexibility and having strong working relationships and partners.

**“Whether it be hydroponic shops, resources for great genetics, vendors and resources for knowledge...all the work seems impossible without good people to work with,”** they say. Nanto Labz says cannabis cultivation has taught them patience, consistency, discipline, sacrifice and even people skills.

In spite of being up against strict UK regulations, Nanto Labz has escalated at an unimaginable pace.

Their newest venture is setting up shop in Thailand. With a brand new website and the ability to venture out from the predominantly Indica premium UK market, the team is looking to make waves.

Nanto Labz says Athena® fit their values of keeping things simple and using plant manipulation/environmental techniques and was a game changer for them. “Athena has the ability to keep things level in ways where others struggle.” According to Nanto Labz, certain strains grown in coco have shown no signs of burns and have exhibited a significant rate of growth. These plants have also reached their point of vigor early on in veg with **Athena® Pro Line**.

The Nanto Labz team says they’re hopeful about what the future will bring with their relationship with Athena®.

“

ATHENA® HAS  
THE ABILITY TO  
**KEEP THINGS LEVEL**  
IN WAYS WHERE  
OTHERS STRUGGLE. ”

- NANTO LABZ



PRO 

Designed for **Professional Large-Scale Cultivators** using **Advanced Fertigation Systems** (Dosatron, Netaflex, Rhythm). Those with prior experience using Salt Lines.

# CULTIVATE AT THE HIGHEST LEVEL

## KEY FEATURES

- Simple 2-part per stage 100% soluble fertilizer
- Requires pre-mixing as a concentrate before batch mixing or injection
- Super-clean formula with no particulates or residue
- Consistent and reliable mineral analysis
- Clean ingredients with extremely low heavy metal content
- Will not clog drippers/emitters or create biofilm
- Streamlines irrigation workflow
- Compatible with all fertigation systems
- Not ideal for hand watering or deep water culture (DWC)
- Long shelf life, reduced storage space and freight costs
- 100% complete formula that needs no additional inputs
- Performs optimally with RO water source
- Contains optimal Calcium Magnesium – no need for additional CaMg
- Works in aeroponic cloners

Scan code  
for Pro Line  
Feed Schedules



 **ATHENA**<sup>®</sup>



**Pro Core**  
SOLUBLE BASE FERTILIZER

CLONE	VEG	FLOWER
☿	☿	☿

- Large prill to ensure consistent batches
- Provides strong baseline nutrition across all stages of plant growth
- Calcium Nitrate PLUS microelement package
- Not just Calcium Nitrate (like competitors)
- Microelements are evenly coated for a clean look and homogenous formula
- Used as a 2-part with Bloom or Grow during all stages



**Pro Grow**  
SOLUBLE VEGETATIVE FERTILIZER

CLONE	VEG	FLOWER
	☿	

- Balanced NPK formula and microelements package
- Contains additional Nitrogen for vegetative growth
- Contains no urea or ammoniacal nitrogen
- Used as a 2-part with Core during vegetative growth



**Pro Bloom**  
SOLUBLE FLOWERING FERTILIZER

CLONE	VEG	FLOWER
☿		☿

- A balanced fertilizer blend of Phosphorus, Potassium, and essential microelements
- Phosphorus and Potassium (PK) included, no boosters needed
- No Nitrogen (like competitors)
- Contains Potassium Sulfate instead of Potassium Nitrate (like competitors)
- Sulfates increase terpene and cannabinoid production (increased secondary metabolite production)
- 9% added Sulfate content



CLONE	VEG	FLOWER
		☿

**Fade**  
ENHANCING FINISHER

- Pre-made fertilizer concentrate
- Mixes clean and quickly in batch reservoir
- Eliminates nitrogen during final weeks of the flowering stage
- Contains optimal levels of calcium and microelements for finish
- Same liquid dilution rate as Pro Core (at 2 lbs per gallon concentrate)
- Replace Pro Core during the final 2 weeks of flower
- Formulated as a liquid due to difficult handling as a dry soluble
- Including microelements means immobile nutrients are always available
- Shown to increase terpenes, potency and color fade

PRO CORE	10 LB BOX	(4.5 KG)	PRO-CORE-10
PRO CORE	25 LB BOX	(11.3 KG)	PRO-CORE-25
PRO CORE	25 LB BAG	(11.3 KG)	PRO-CORE-25B
PRO GROW	10 LB BOX	(4.5 KG)	PRO-GW-10
PRO GROW	25 LB BOX	(11.3 KG)	PRO-GW-25
PRO GROW	25 LB BAG	(11.3 KG)	PRO-GW-25B

PRO BLOOM	10 LB BOX	(4.5 KG)	PRO-BL-10
PRO BLOOM	25 LB BOX	(11.3 KG)	PRO-BL-25
PRO BLOOM	25 LB BAG	(11.3 KG)	PRO-BL-25B
FADE	32 OZ	(0.94 L)	PRO-FD-32OZ
FADE	1 GAL	(3.78 L)	PRO-FD-1G
FADE	5 GAL	(18.92 L)	PRO-FD-5G

FADE	55 GAL	(208.2 L)	PROB-FD-55G
FADE	275 GAL	(1041 L)	PROB-FD-275G

FEED PROGRAM						All measurements are mL per 10 L based on 226 grams per liter stock tank concentrate.								
MIXING ORDER ↓	CLONE	VEG				FLOWER								
	Pre-Soak & Feed	W1	W2	W3	W4	W1	W2	W3	W4	W5	W6	W7	W8	W9
Balance	*Use as pH up	<b>Balance:</b> Recommended for batch tank mixing and Dosatron. Do not use with Netaflex.												
Pro Balance		<b>Pro Balance:</b> Recommended for advanced irrigation systems like Netaflex. *If using Blended Balance, do not use an additional potassium silicate product.												
Pro Grow		90	90	90	90									
Pro Bloom	57					90	90	90	90	90	90	90	90	90
Pro Core	34	54	54	54	54	54	54	54	54	54	54	*54	**Swap Fade	
Fade						*Swap Core with Fade W8-9 of Flower. This is cultivar dependent. If the cultivar shows resiliency, use Fade (51 mL) weeks 7-9.						51	51	
Cleanse	3	5-13	5-13	5-13	5-13	5-13	5-13	5-13	5-13	5-13	5-13	5-13	5-13	5-13
EC	2.0	3.0	3.0	3.0	3.0	3.0	3.0	3.0	3.0	3.0	3.0	3.0	3.0	3.0
PPM 500	1000	1500	1500	1500	1500	1500	1500	1500	1500	1500	1500	1500	1500	1500
PPM 700	1400	2100	2100	2100	2100	2100	2100	2100	2100	2100	2100	2100	2100	2100
pH	5.6	5.8-6.2 (Coco/Rockwool)		6.0-6.4 (Peat based mediums)		5.8-6.2 (Coco/Rockwool)			6.0-6.4 (Peat based mediums)			6.0-6.4 (All)		

SPRAY PROGRAM						All measurements are mL per L			
APPLICATION FREQUENCY			VEG				FLOWER		
			W1	W2	W3	W4	W1	W2	W3
IPM	Preventative	2x Week	24	24	24	24	24	24	24
	Pressure	3x Week	32	32	32	32	32	32	32
Stack	Maximize	2x Week	2	2	2	2	2	2	

Can be mixed together with IPM

PRE-SOAK
<b>Coco</b>
• pH 5.5 - 5.8
• EC 3.5 - 4.0
<b>Rockwool</b>
• pH 5.0 - 5.5
• EC 2.5 - 3.0

FLUSH	
RO + Cleanse	26 mL
EC	<0.1
PPM 500	<50
PPM 700	<70
pH	6.0 - 6.4
<b>Coco</b>	
Last 3 days	
<b>Rockwool</b>	
Last day	

**DISCLAIMER** - This is a baseline recommendation. Any adjustments made are at the growers discretion. Adjust the feed chart according to weeks needed to complete a run. Strain dependent.

Read the entire Directions for Use, Conditions of Warranties, and Limitations of Liability before using this product. If the terms are not acceptable, return the unopened product container at once. By using this product, user or buyer accepts the following Conditions, Disclaimer of Warranties, and Limitations of Liability. CONDITIONS: The directions for use of this product are believed to be adequate and must be followed carefully. However, it is impossible to eliminate all risks associated with the use of this product. Crop injury, ineffectiveness, or other unintended consequences may result because of such factors such as weather conditions, presence of other materials, or the manner of use or application, all of which are beyond the control of Athena Ag, Inc. All such risks shall be assumed by the user or buyer. DISCLAIMER OF WARRANTIES: To the extent consistent with applicable law, Athena Ag, Inc. makes no other warranties, express or implied, of merchantability or of fitness for a particular purpose or otherwise, that extend beyond the statements made on the product's label. No agent of Athena Ag, Inc. is authorized to make any warranties beyond those contained herein or to modify the warranties contained herein. To the extent consistent with applicable law, Athena Ag, Inc. disclaims any liability whatsoever for special, incidental, or consequential damages resulting from the use or handling of this product. LIMITATIONS OF LIABILITY: To the extent consistent with applicable law, the exclusive remedy of the user or buyer for any and all losses, injuries, or damages resulting from the use or handling of this product, whether in contract, warranty, tort, negligence, strict liability or otherwise, shall not exceed the purchase price paid, or at Athena Ag Inc's election, the replacement of product.



FEED PROGRAM						Pro Line is grams per 10 L, Cleanse & Fade are mL per 10 L								
MIXING ORDER ↓	CLONE	VEG				FLOWER								
	Pre-Soak & Feed	W1	W2	W3	W4	W1	W2	W3	W4	W5	W6	W7	W8	W9
Balance	*Use as pH up	Balance: Recommended for batch tank mixing and Dosatron. Do not use with Netaflex.												
Pro Balance		Pro Balance: Recommended for advanced irrigation systems like Netaflex. *If using Blended Balance, do not use an additional potassium silicate product.												
Pro Grow		20.3	20.3	20.3	20.3									
Pro Bloom	12.9					20.3	20.3	20.3	20.3	20.3	20.3	20.3	20.3	20.3
Pro Core	7.7	12.2	12.2	12.2	12.2	12.2	12.2	12.2	12.2	12.2	12.2	*12.2	**Swap Fade	
Fade		*Swap Core with Fade W8-9 of Flower. This is cultivar dependent. If the cultivar shows resiliency, use Fade (51 mL) weeks 7-9.										51	51	
Cleanse	3	5-13	5-13	5-13	5-13	5-13	5-13	5-13	5-13	5-13	5-13	5-13	5-13	5-13
EC	2.0	3.0	3.0	3.0	3.0	3.0	3.0	3.0	3.0	3.0	3.0	3.0	3.0	3.0
PPM 500	1000	1500	1500	1500	1500	1500	1500	1500	1500	1500	1500	1500	1500	1500
PPM 700	1400	2100	2100	2100	2100	2100	2100	2100	2100	2100	2100	2100	2100	2100
pH	5.6	5.8-6.2 (Coco/Rockwool)		6.0-6.4 (Peat based mediums)		5.8-6.2 (Coco/Rockwool)			6.0-6.4 (Peat based mediums)			6.0-6.4 (All)		
**When switching to Fade verify pH.														

SPRAY PROGRAM						All measurements are mL per L			
APPLICATION FREQUENCY			VEG				FLOWER		
			W1	W2	W3	W4	W1	W2	W3
IPM	Preventative	2x Week	24	24	24	24	24	24	24
	Pressure	3x Week	32	32	32	32	32	32	32
Stack	Maximize	2x Week	2	2	2	2	2	2	
Can be mixed together with IPM									

**PRE-SOAK**

Coco

- pH 5.5 - 5.8
- EC 3.5 - 4.0

Rockwool

- pH 5.0 - 5.5
- EC 2.5 - 3.0

**FLUSH**

RO + Cleanse	26 mL
EC	<0.1
PPM 500	<50
PPM 700	<70
pH	6.0 - 6.4
<b>Coco</b> Last 3 days	
<b>Rockwool</b> Last day	

NOTE: For highest accuracy + consistency, Athena® recommends mixing from a stock tank. Follow our Pro Concentrate Procedure.



**DISCLAIMER** - This is a baseline recommendation. Any adjustments made are at the growers discretion. Adjust the feed chart according to weeks needed to complete a run. Strain dependent.

Read the entire Directions for Use, Conditions of Warranties, and Limitations of Liability before using this product. If the terms are not acceptable, return the unopened product container at once. By using this product, user or buyer accepts the following Conditions, Disclaimer of Warranties, and Limitations of Liability. CONDITIONS: The directions for use of this product are believed to be adequate and must be followed carefully. However, it is impossible to eliminate all risks associated with the use of this product. Crop injury, ineffectiveness, or other unintended consequences may result because of such factors such as weather conditions, presence of other materials, or the manner of use or application, all of which are beyond the control of Athena Ag, Inc. All such risks shall be assumed by the user or buyer. DISCLAIMER OF WARRANTIES: To the extent consistent with applicable law, Athena Ag, Inc. makes no other warranties, express or implied, of merchantability or of fitness for a particular purpose or otherwise, that extend beyond the statements made on the product's label. No agent of Athena Ag, Inc. is authorized to make any warranties beyond those contained herein or to modify the warranties contained herein. To the extent consistent with applicable law, Athena Ag, Inc. disclaims any liability whatsoever for special, incidental, or consequential damages resulting from the use or handling of this product. LIMITATIONS OF LIABILITY: To the extent consistent with applicable law, the exclusive remedy of the user or buyer for any and all losses, injuries, or damages resulting from the use or handling of this product, whether in contract, warranty, tort, negligence, strict liability or otherwise, shall not exceed the purchase price paid, or at Athena Ag Inc's election, the replacement of product.

Follow us on Instagram!

STEP 1

STOCK CONCENTRATE PROCEDURE

**CAUTION: A CONCENTRATE SHOULD NEVER BE FED DIRECTLY TO YOUR PLANTS. THE CONCENTRATE MIX IS MEANT FOR MAKING A BATCH RESERVOIR.**

**226** CONCENTRATE MIX RATE  
**GRAMS/LITER**

If using a different concentrate mix rate, see **Dosage Reference Guide**.



**1A** Fill container with water to about **80% of final volume.**



**1B** Empty entire contents of **Pro Line Bag**. (always use a full bag)

11.36 KG

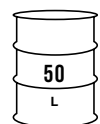

**1C** Mix thoroughly until all granules are dissolved. (approx 15-45 minutes)



**1D** Top off container to **final volume**. Mix one final time for 1-2 minutes to ensure stock tank uniformity before validating.

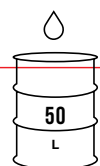

**RECOMMENDED:**

Use **Concentrate Validation Procedure** to ensure proper EC has been achieved prior to feeding plants.



Athena® Pro Bags

If desired EC is achieved, proceed to making a **Batch Reservoir**.

STEP 2

BATCH RESERVOIR PROCEDURE

**NOTE: USE YOUR STOCK CONCENTRATE TO MIX A RESERVOIR TO FEED DIRECTLY TO PLANTS.**

This procedure is for hand mixing a batch reservoir. If you are using a dosing system, refer to our **Irrigation Systems** document.



**2A** Fill reservoir with water and add **Balance**.

Follow our **Balance Procedure**.



**2B** Use this chart to determine the proper dosage of each **Pro Line** concentrate.

Dosage in mL/10 L 226 grams/Liter CONCENTRATE		
TARGET EC	PRO GROW / PRO BLOOM	PRO CORE
1.0	27 mL	16 mL
1.5	42 mL	25 mL
2.0	57 mL	34 mL
2.5	73 mL	44 mL
3.0	90 mL	54 mL
3.5	107 mL	64 mL
4.0	124 mL	75 mL

**2C** Measure each concentrate and add to reservoir separately.

**CAUTION: COMBINING PRODUCTS IN CONCENTRATE FORM WILL GENERATE PRECIPITATION.**

For example: If you have a 200 liter reservoir and wish to feed 3.0 EC **Pro Core** and **Pro Bloom** here is what to do:

**90 mL Pro Bloom**  
x 20 (200 liter reservoir)  
= **1800 mL concentrate**  
(90x20=1800 mL)

**54 mL Pro Core**  
x 20 (200 liter reservoir)  
= **1080 mL concentrate**  
(54x20=1080 mL)

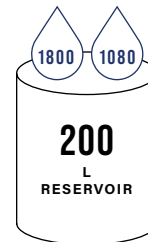

**2D** Mix thoroughly; check EC and pH.

If EC is off, **troubleshoot.**



If EC is on, **let's feed.**



Read the entire Directions for Use, Conditions of Warranties, and Limitations of Liability before using this product. If the terms are not acceptable, return the unopened product container at once. By using this product, user or buyer accepts the following Conditions, Disclaimer of Warranties, and Limitations of Liability. CONDITIONS: The directions for use of this product are believed to be adequate and must be followed carefully. However, it is impossible to eliminate all risks associated with the use of this product. Crop injury, ineffectiveness, or other unintended consequences may result because of such factors such as weather conditions, presence of other materials, or the manner of use or application, all of which are beyond the control of Athena Ag, Inc. All such risks shall be assumed by the user or buyer. DISCLAIMER OF WARRANTIES: To the extent consistent with applicable law, Athena Ag, Inc. makes no other warranties, express or implied, of merchantability or of fitness for a particular purpose or otherwise, that extend beyond the statements made on the product's label. No agent of Athena Ag, Inc. is authorized to make any warranties beyond those contained herein or to modify the warranties contained herein. To the extent consistent with applicable law, Athena Ag, Inc. disclaims any liability whatsoever for special, incidental, or consequential damages resulting from the use or handling of this product. LIMITATIONS OF LIABILITY: To the extent consistent with applicable law, the exclusive remedy of the user or buyer for any and all losses, injuries, or damages resulting from the use or handling of this product, whether in contract, warranty, tort, negligence, strict liability or otherwise, shall not exceed the purchase price paid, or at Athena Ag Inc's election, the replacement of product.



STEP 1

STOCK CONCENTRATE PROCEDURE



**CAUTION:** A CONCENTRATE SHOULD NEVER BE FED DIRECTLY TO YOUR PLANTS. THE CONCENTRATE MIX IS MEANT FOR MAKING A BATCH RESERVOIR.

**226** CONCENTRATE MIX RATE  
**GRAMS/LITER**

If using a different concentrate mix rate, see **Dosage Reference Guide**.



**1A** Fill container with water to about **80% of final volume**.

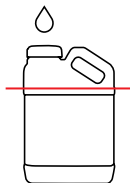

**1B** Empty entire contents of **Pro Line Pouch**. (always use a full pouch)

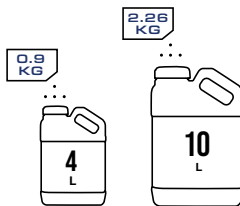

**1C** Mix thoroughly until all granules are dissolved. (approx 15-45 minutes)



**1D** Top off container to **final volume**. Mix one final time for 1-2 minutes to ensure stock tank uniformity before validating.

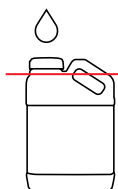

Athena® Pro Boxes

**RECOMMENDED:** Use **Concentrate Validation Procedure** to ensure proper EC has been achieved prior to feeding plants.



If desired EC is achieved, proceed to making a **Batch Reservoir**.

STEP 2

BATCH RESERVOIR PROCEDURE



**NOTE:** USE YOUR STOCK CONCENTRATE TO MIX A RESERVOIR TO FEED DIRECTLY TO PLANTS.

This procedure is for hand mixing a batch reservoir. If you are using a dosing system, refer to our **Irrigation Systems document**.



**2A** Fill reservoir with water and add **Balance**.

Follow our **Balance Procedure**.



**2B** Use this chart to determine the proper dosage of each **Pro Line** concentrate.

Dosage in mL/10 L 226 grams/Liter CONCENTRATE		
TARGET EC	PRO GROW / PRO BLOOM	PRO CORE
1.0	27 mL	16 mL
1.5	42 mL	25 mL
2.0	57 mL	34 mL
2.5	73 mL	44 mL
3.0	90 mL	54 mL
3.5	107 mL	64 mL
4.0	124 mL	75 mL

**2C** Measure each concentrate and add to reservoir separately.

**CAUTION:** COMBINING PRODUCTS IN CONCENTRATE FORM WILL GENERATE PRECIPITATION.

For example: If you have a 200 liter reservoir and wish to feed 3.0 EC **Pro Core** and **Pro Bloom** here is what to do:

**90 mL Pro Bloom**  
x 20 (200 liter reservoir)  
= **1800 mL concentrate**  
(90x20=1800 mL)

**54 mL Pro Core**  
x 20 (200 liter reservoir)  
= **1080 mL concentrate**  
(54x20=1080 mL)

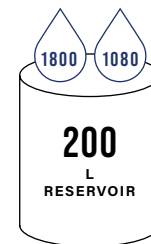

**2D** Mix thoroughly; check EC and pH.

If EC is off, **troubleshoot**.



If EC is on, **let's feed**.



Read the entire Directions for Use, Conditions of Warranties, and Limitations of Liability before using this product. If the terms are not acceptable, return the unopened product container at once. By using this product, user or buyer accepts the following Conditions, Disclaimer of Warranties, and Limitations of Liability. CONDITIONS: The directions for use of this product are believed to be adequate and must be followed carefully. However, it is impossible to eliminate all risks associated with the use of this product. Crop injury, ineffectiveness, or other unintended consequences may result because of such factors such as weather conditions, presence of other materials, or the manner of use or application, all of which are beyond the control of Athena Ag, Inc. All such risks shall be assumed by the user or buyer. DISCLAIMER OF WARRANTIES: To the extent consistent with applicable law, Athena Ag, Inc. makes no other warranties, express or implied, of merchantability or of fitness for a particular purpose or otherwise, that extend beyond the statements made on the product's label. No agent of Athena Ag, Inc. is authorized to make any warranties beyond those contained herein or to modify the warranties contained herein. To the extent consistent with applicable law, Athena Ag, Inc. disclaims any liability whatsoever for special, incidental, or consequential damages resulting from the use or handling of this product. LIMITATIONS OF LIABILITY: To the extent consistent with applicable law, the exclusive remedy of the user or buyer for any and all losses, injuries, or damages resulting from the use or handling of this product, whether in contract, warranty, tort, negligence, strict liability or otherwise, shall not exceed the purchase price paid, or at Athena Ag Inc.'s election, the replacement of product.



# LO-FLO PANEL CONFIGURATION



## AUTOMATE YOUR PROGRAM

Dosatrons provide precise and consistent delivery of fertilizers, nutrients, or additives, ensuring each plant receives the correct amount for optimal growth. This automation saves time and labor, reduces waste and cost, and minimizes the risk of human error.

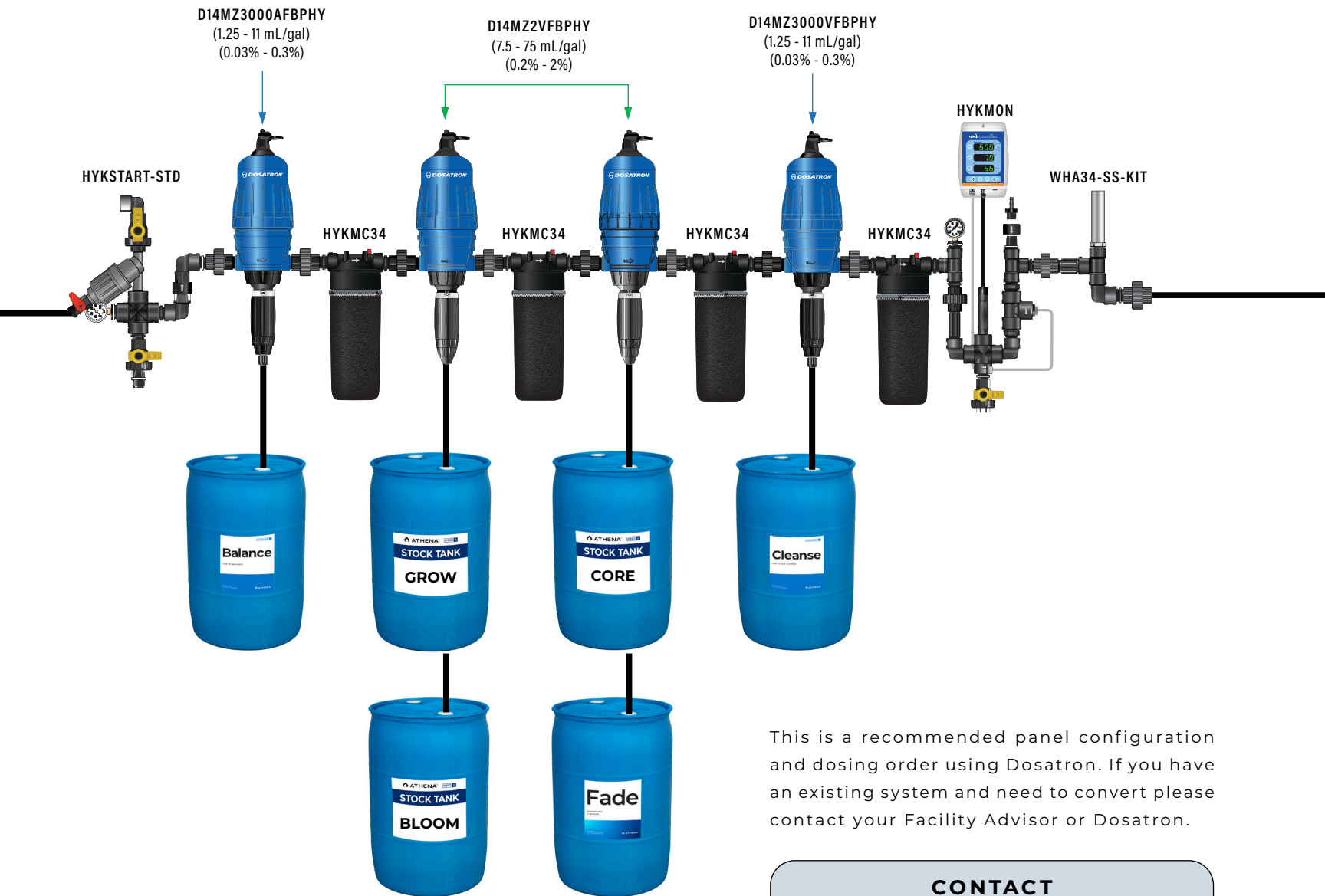

This is a recommended panel configuration and dosing order using Dosatron. If you have an existing system and need to convert please contact your Facility Advisor or Dosatron.

### CONTACT

**ATHENA®  
FACILITY ADVISOR:**

**844-333-1818 #4**

**DOSATRON**

**1-800-523-8499**



**WARNING: IF THE PROPER MIXING ORDER IS NOT FOLLOWED, FORMATION OF PRECIPITATES MAY OCCUR AND IRRIGATION LINES MAY CLOG.**

Read the entire Directions for Use, Conditions of Warranties, and Limitations of Liability before using this product. If the terms are not acceptable, return the unopened product container at once. By using this product, user or buyer accepts the following Conditions, Disclaimer of Warranties, and Limitations of Liability. CONDITIONS: The directions for use of this product are believed to be adequate and must be followed carefully. However, it is impossible to eliminate all risks associated with the use of this product. Crop injury, ineffectiveness, or other unintended consequences may result because of such factors such as weather conditions, presence of other materials, or the manner of use or application, all of which are beyond the control of Athena Ag, Inc. All such risks shall be assumed by the user or buyer. DISCLAIMER OF WARRANTIES: To the extent consistent with applicable law, Athena Ag, Inc. makes no other warranties, express or implied, of merchantability or of fitness for a particular purpose or otherwise, that extend beyond the statements made on the product's label. No agent of Athena Ag, Inc. is authorized to make any warranties beyond those contained herein or to modify the warranties contained herein. To the extent consistent with applicable law, Athena Ag, Inc. disclaims any liability whatsoever for special, incidental, or consequential damages resulting from the use or handling of this product. LIMITATIONS OF LIABILITY: To the extent consistent with applicable law, the exclusive remedy of the user or buyer for any and all losses, injuries, or damages resulting from the use or handling of this product, whether in contract, warranty, tort, negligence, strict liability or otherwise, shall not exceed the purchase price paid, or at Athena Ag Inc's election, the replacement of product.

Follow us on Instagram!



# HI-FLO PANEL CONFIGURATION



## AUTOMATE YOUR PROGRAM



Dosatrons provide precise and consistent delivery of fertilizers, nutrients, or additives, ensuring each plant receives the correct amount for optimal growth. This automation saves time and labor, reduces waste and cost, and minimizes the risk of human error.

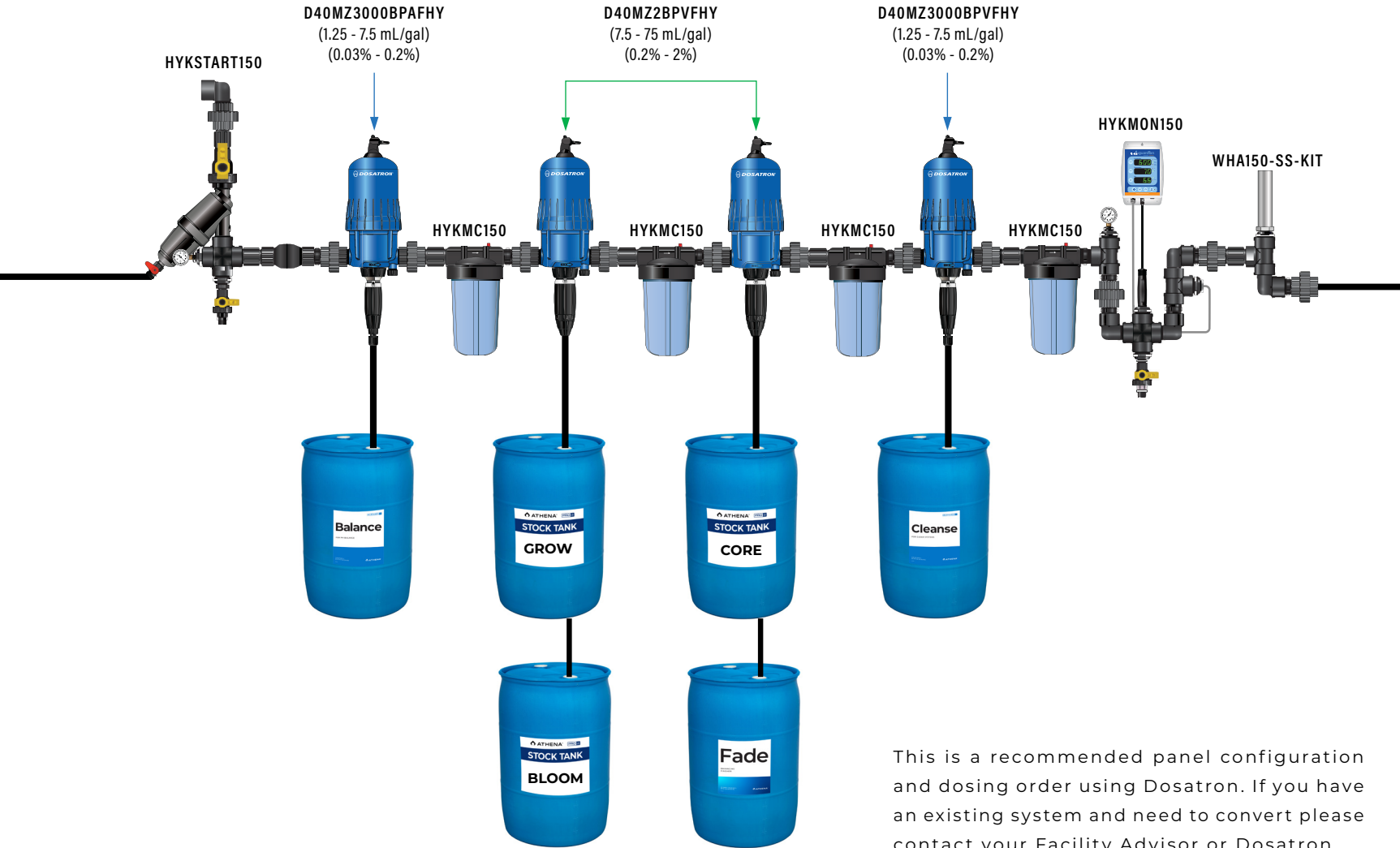

This is a recommended panel configuration and dosing order using Dosatron. If you have an existing system and need to convert please contact your Facility Advisor or Dosatron.

### CONTACT

ATHENA®  
FACILITY ADVISOR:

844-333-1818 #4

DOSATRON

1-800-523-8499



**WARNING:** IF THE PROPER MIXING ORDER IS NOT FOLLOWED, FORMATION OF PRECIPITATES MAY OCCUR AND IRRIGATION LINES MAY CLOG.

Read the entire Directions for Use, Conditions of Warranties, and Limitations of Liability before using this product. If the terms are not acceptable, return the unopened product container at once. By using this product, user or buyer accepts the following Conditions, Disclaimer of Warranties, and Limitations of Liability. CONDITIONS: The directions for use of this product are believed to be adequate and must be followed carefully. However, it is impossible to eliminate all risks associated with the use of this product. Crop injury, ineffectiveness, or other unintended consequences may result because of such factors such as weather conditions, presence of other materials, or the manner of use or application, all of which are beyond the control of Athena Ag, Inc. All such risks shall be assumed by the user or buyer. DISCLAIMER OF WARRANTIES: To the extent consistent with applicable law, Athena Ag, Inc. makes no other warranties, express or implied, of merchantability or of fitness for a particular purpose or otherwise, that extend beyond the statements made on the product's label. No agent of Athena Ag, Inc. is authorized to make any warranties beyond those contained herein or to modify the warranties contained herein. To the extent consistent with applicable law, Athena Ag, Inc. disclaims any liability whatsoever for special, incidental, or consequential damages resulting from the use or handling of this product. LIMITATIONS OF LIABILITY: To the extent consistent with applicable law, the exclusive remedy of the user or buyer for any and all losses, injuries, or damages resulting from the use or handling of this product, whether in contract, warranty, tort, negligence, strict liability or otherwise, shall not exceed the purchase price paid, or at Athena Ag Inc.'s election, the replacement of product.

Follow us on Instagram!

@Athena.Ag

A01.001

AthenaAg.com



113 grams/Liter CONCENTRATE								
Combined EC	Pro Bloom/Grow				Pro Core			
	mL/liter	mL/10 L	Injector %	EC	mL/liter	mL/10 L	Injector %	EC
0.5	2.5	24.9	0.25%	0.3	1.5	15.0	0.15%	0.2
1.0	5.4	53.6	0.54%	0.6	3.2	32.2	0.32%	0.5
1.5	8.3	83.4	0.83%	1.0	5.0	50.0	0.50%	0.7
2.0	11.4	114.3	1.14%	1.3	6.9	68.6	0.69%	1.0
2.5	14.6	146.3	1.46%	1.6	8.8	87.8	0.88%	1.2
3.0	17.9	179.4	1.79%	1.9	10.8	107.6	1.08%	1.5
3.5	21.4	213.6	2.14%	2.2	12.8	128.2	1.28%	1.7
4.0	24.9	248.9	2.49%	2.5	14.9	149.3	1.49%	2.0
4.5	28.5	285.3	2.85%	2.9	17.1	171.2	1.71%	2.2
5.0	32.3	322.8	3.23%	3.2	19.4	193.7	1.94%	2.5
5.5	36.1	361.4	3.61%	3.5	21.7	216.8	2.17%	2.7
6.0	40.1	401.1	4.01%	3.8	24.1	240.7	2.41%	2.9

226 grams/Liter CONCENTRATE								
Combined EC	Pro Bloom/Grow				Pro Core			
	mL/liter	mL/10 L	Injector %	EC	mL/liter	mL/10 L	Injector %	EC
0.5	1.2	12.5	0.12%	0.3	0.7	7.5	0.07%	0.2
1.0	2.7	26.8	0.27%	0.6	1.6	16.1	0.16%	0.5
1.5	4.2	41.7	0.42%	1.0	2.5	25.0	0.25%	0.7
2.0	5.7	57.2	0.57%	1.3	3.4	34.3	0.34%	1.0
2.5	7.3	73.1	0.73%	1.6	4.4	43.9	0.44%	1.2
3.0	9.0	89.7	0.90%	1.9	5.4	53.8	0.54%	1.5
3.5	10.7	106.8	1.07%	2.2	6.4	64.1	0.64%	1.7
4.0	12.4	124.4	1.24%	2.5	7.5	74.7	0.75%	2.0
4.5	14.3	142.6	1.43%	2.9	8.6	85.6	0.86%	2.2
5.0	16.1	161.4	1.61%	3.2	9.7	96.8	0.97%	2.5
5.5	18.1	180.7	1.81%	3.5	10.8	108.4	1.08%	2.7
6.0	20.1	200.5	2.01%	3.8	12.0	120.3	1.20%	2.9

### Using Dosatron with Athena® Pro Line

Always mix a stock concentrate according to our procedure for use with a Dosatron. Injector settings are not precise and may require fine-tuning to hit target EC and pH. We recommend setting to the above recommendations, based on target EC then running to waste while fine-tuning settings. Always set each fertilizer part EC individually before combining in final solution.



Read the entire Directions for Use, Conditions of Warranties, and Limitations of Liability before using this product. If the terms are not acceptable, return the unopened product container at once. By using this product, user or buyer accepts the following Conditions, Disclaimer of Warranties, and Limitations of Liability. CONDITIONS: The directions for use of this product are believed to be adequate and must be followed carefully. However, it is impossible to eliminate all risks associated with the use of this product. Crop injury, ineffectiveness, or other unintended consequences may result because of such factors such as weather conditions, presence of other materials, or the manner of use or application, all of which are beyond the control of Athena Ag, Inc. All such risks shall be assumed by the user or buyer. DISCLAIMER OF WARRANTIES: To the extent consistent with applicable law, Athena Ag, Inc. makes no other warranties, express or implied, of merchantability or of fitness for a particular purpose or otherwise, that extend beyond the statements made on the product's label. No agent of Athena Ag, Inc. is authorized to make any warranties beyond those contained herein or to modify the warranties contained herein. To the extent consistent with applicable law, Athena Ag, Inc. disclaims any liability whatsoever for special, incidental, or consequential damages resulting from the use or handling of this product. LIMITATIONS OF LIABILITY: To the extent consistent with applicable law, the exclusive remedy of the user or buyer for any and all losses, injuries, or damages resulting from the use or handling of this product, whether in contract, warranty, tort, negligence, strict liability or otherwise, shall not exceed the purchase price paid, or at Athena Ag Inc.'s election, the replacement of product.

Follow us on Instagram!

Dosage in mL/10 L		
113 grams/Liter CONCENTRATE		
TARGET EC	PRO GROW/BLOOM	PRO CORE
1.0	54 mL	32 mL
1.5	83 mL	50 mL
2.0	114 mL	69 mL
2.5	146 mL	88 mL
3.0	179 mL	108 mL
3.5	214 mL	128 mL
4.0	249 mL	149 mL

Dosage in grams/10 L		
MEASURING BY WEIGHT		
EC	grams/10 L	
	Pro Grow/Bloom	Pro Core
0.5	2.8	1.7
1.0	6.1	3.6
1.5	9.4	5.7
2.0	12.9	7.7
2.5	16.5	9.9
3.0	20.3	12.2
3.5	24.1	14.5
4.0	28.1	16.9

RECOMMENDED Dosage in mL/10 L		
226 grams/Liter CONCENTRATE		
TARGET EC	PRO GROW/BLOOM	PRO CORE
1.0	27 mL	16 mL
1.5	42 mL	25 mL
2.0	57 mL	34 mL
2.5	73 mL	44 mL
3.0	90 mL	54 mL
3.5	107 mL	64 mL
4.0	124 mL	75 mL

Pro Line			
STOCK CONCENTRATE			
Number of 11.3 kg bags	grams/Liter		
	113 g	226 g	282 g
1	100	50	40
2	200	100	80
3	300	150	120
4	400	200	160
5	500	250	200

Stock Tank (liters of water)

Dosage in mL/10 L		
282 grams/Liter CONCENTRATE		
TARGET EC	PRO GROW/BLOOM	PRO CORE
1.0	21 mL	13 mL
1.5	33 mL	20 mL
2.0	46 mL	27 mL
2.5	59 mL	35 mL
3.0	72 mL	43 mL
3.5	86 mL	51 mL
4.0	100 mL	60 mL

Pro Balance				
STOCK CONCENTRATE				
Pouch Size	grams/Liter			
	28 g	57 g	85 g	113 g
0.9 kg	32	16	11	8
2.26 kg	80	40	27	20

Stock Tank (liters of water)



NOTE: AT 282 GRAMS PER LITER, STOCK TANK MUST BE AGITATED.

Read the entire Directions for Use, Conditions of Warranties, and Limitations of Liability before using this product. If the terms are not acceptable, return the unopened product container at once. By using this product, user or buyer accepts the following Conditions, Disclaimer of Warranties, and Limitations of Liability. CONDITIONS: The directions for use of this product are believed to be adequate and must be followed carefully. However, it is impossible to eliminate all risks associated with the use of this product. Crop injury, ineffectiveness, or other unintended consequences may result because of such factors as weather conditions, presence of other materials, or the manner of use or application, all of which are beyond the control of Athena Ag, Inc. All such risks shall be assumed by the user or buyer. DISCLAIMER OF WARRANTIES: To the extent consistent with applicable law, Athena Ag, Inc. makes no other warranties, express or implied, of merchantability or of fitness for a particular purpose or otherwise, that extend beyond the statements made on the product's label. No agent of Athena Ag, Inc. is authorized to make any warranties beyond those contained herein or to modify the warranties contained herein. To the extent consistent with applicable law, Athena Ag, Inc. disclaims any liability whatsoever for special, incidental, or consequential damages resulting from the use or handling of this product. LIMITATIONS OF LIABILITY: To the extent consistent with applicable law, the exclusive remedy of the user or buyer for any and all losses, injuries, or damages resulting from the use or handling of this product, whether in contract, warranty, tort, negligence, strict liability or otherwise, shall not exceed the purchase price paid, or at Athena Ag Inc.'s election, the replacement of product.

Follow us on Instagram!

 @Athena.Ag

A01.004

AthenaAg.com

 ATHENA®



 **ATHENA**<sup>®</sup>

**PRO** 

# **PRECISION IRRIGATION STRATEGY**

Created by Jay Yokiell  
@SaltsandLEDs

**PRECISION FOR SUCCESS**

The key to achieving optimal plant growth depends on making precise adjustments to both the environment and rootzone. Once all environmental factors are properly managed, implementing a proper irrigation strategy can elevate your cultivation to the next level. In this guide to Precision Irrigation Strategy we will familiarize you with the common terms, necessary tools, and techniques that lead to precision and success.

**NECESSARY TOOLS**

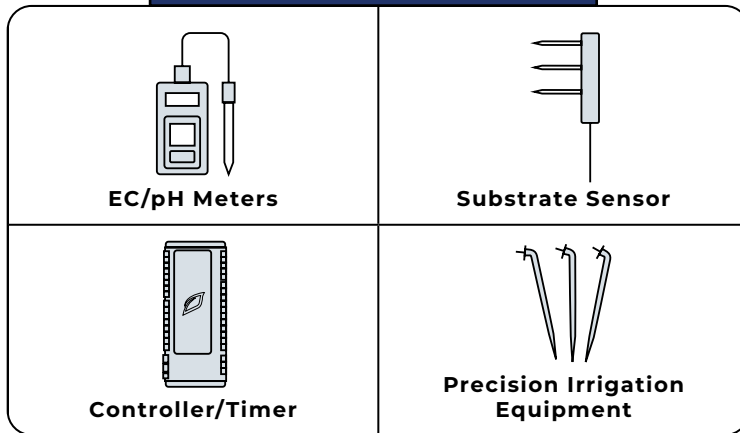

**COMMON IRRIGATION TERMS**

<b>Volumetric Water Content (VWC%):</b> The volume of water a substrate is holding at any given time.
<b>Shot:</b> A single irrigation event.
<b>Maintenance Shots:</b> P2 irrigation events that maintain Peak VWC% Target throughout the day.
<b>Field Capacity:</b> Maximum VWC% of a substrate prior to runoff.
<b>Full Saturation:</b> When a substrate can no longer hold anymore water and peak VWC% can no longer increase.
<b>Runoff:</b> Water that is drained from a substrate .
<b>Dryback:</b> The period between irrigation events when the substrate is drying out.
<b>Additional Dryback:</b> The decrease in VWC% that occurs during P3, after the lights turn on and before the first irrigation event of the day.
<b>Pore water EC (pwEC):</b> The EC of the water within the pores of the substrate. (We also refer to this as Substrate EC in this document).
<b>Input EC:</b> The EC of the solution applied through irrigation events.
<b>Peak VWC% Target:</b> The goal for maximum VWC% established by the last P1 event and maintained throughout the P2 phase.
<b>EC Stacking:</b> The strategy of limiting runoff with bigger overnight drybacks, to increase substrate EC.

**OPTIMAL ENVIRONMENT**

	VEG	FLOWER STRETCH	FLOWER BULK	FLOWER FINISH
Temp	22.2° - 27.7° C	25.5° - 27.7° C	23.8° - 26.6° C	18.3° - 22.2° C
RH	58 - 75%	60 - 72%	60 - 70%	50 - 60%
VPD	0.8 - 1.0 kPa	1.0 - 1.2 kPa	1.0 - 1.2 kPa	1.2 - 1.4 kPa
PPFD	300 - 600	600 - 1000	850 - 1200	600 - 900

**SUBSTRATE SIZING**

A proper Precision Irrigation Strategy is best achieved with smaller pot sizes. Using smaller containers allows a substrate to dry back faster, enabling the grower to easily manipulate and fine-tune substrate EC through strategic irrigation events.

Pot size based on veg time:



**RECOMMENDED SUBSTRATE TYPES**

	<p><b>100% Coco:</b> A homogeneous substrate that allows substrate sensors to have more consistent readings without interference from aeration material such as perlite.</p> <p><b>Pot Type:</b> Compressed pre-filled or fabric pots</p> <p><b>Pot Size:</b> 4-10 liters</p>
	<p><b>Rockwool:</b> A homogeneous substrate with a consistent field capacity and quick dryback allowing easy control over substrate EC.</p> <p><b>Rockwool Size:</b> Hugo 15 cm x 15 cm or Delta 10 cm x 10 cm on Unislab or Multi Plant Slab.</p>

**WARNING: RUNNING A HIGH SUBSTRATE EC MAY BURN YOUR PLANTS WHEN ALL ENVIRONMENTAL FACTORS ARE NOT WITHIN THE CORRECT RANGES.**

Read the entire Directions for Use, Conditions of Warranties, and Limitations of Liability before using this product. If the terms are not acceptable, return the unopened product container at once. By using this product, user or buyer accepts the following Conditions, Disclaimer of Warranties, and Limitations of Liability. CONDITIONS: The directions for use of this product are believed to be adequate and must be followed carefully. However, it is impossible to eliminate all risks associated with the use of this product. Crop injury, ineffectiveness, or other unintended consequences may result because of such factors such as weather conditions, presence of other materials, or the manner of use or application, all of which are beyond the control of Athena Ag, Inc. All such risks shall be assumed by the user or buyer. DISCLAIMER OF WARRANTIES: To the extent consistent with applicable law, Athena Ag, Inc. makes no other warranties, express or implied, of merchantability or of fitness for a particular purpose or otherwise, that extend beyond the statements made on the product's label. No agent of Athena Ag, Inc. is authorized to make any warranties beyond those contained herein or to modify the warranties contained herein. To the extent consistent with applicable law, Athena Ag, Inc. disclaims any liability whatsoever for special, incidental, or consequential damages resulting from the use or handling of this product. LIMITATIONS OF LIABILITY: To the extent consistent with applicable law, the exclusive remedy of the user or buyer for any and all losses, injuries, or damages resulting from the use or handling of this product, whether in contract, warranty, tort, negligence, strict liability or otherwise, shall not exceed the purchase price paid, or at Athena Ag Inc.'s election, the replacement of product.

WHAT IS CROP STEERING?

Crop steering is an advanced cultivation technique that manipulates key factors of growing, such as irrigation, temperature, humidity, and light to precisely guide plant growth towards desired outcomes. Crop steering effectively encourages either **Vegetative** or **Generative** growth by strategically inducing stress at specific growth stages. **Precision Irrigation Strategy** utilizes both types of crop steering. Finding the right balance is crucial for achieving high quality flower.

CROP STEERING OPTIMIZES:



**PLANT DEVELOPMENT**

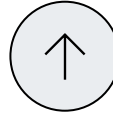

**YIELD**



**FLOWER QUALITY**

2 Types of Crop Steering

**VEGETATIVE**

A smaller dryback (low substrate EC) promotes **Vegetative Growth**, resulting in taller plants and swelling of the buds.

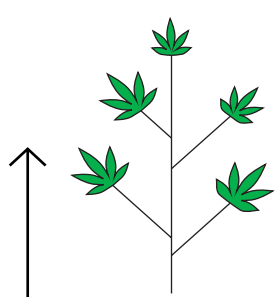
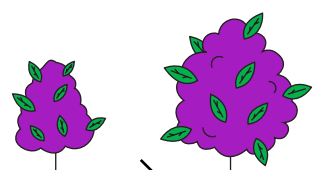
Taller plants

**LESS STRESS**

Bud swell

**GENERATIVE**

A larger dryback (high substrate EC) encourages **Generative Growth**, leading to quicker flower site formation and compact plants.

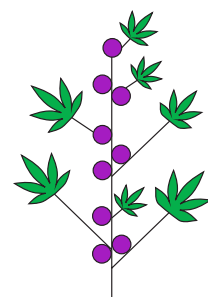
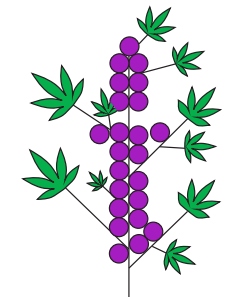
Flower site formation

**MORE STRESS**

Compact plant

VEGETATIVE	GENERATIVE
<p><b>P1</b></p> <p>Peak VWC% Target above field capacity to increase runoff.</p> <p><b>MORE RUNOFF</b></p>	<p><b>P1</b></p> <p>Peak VWC% Target equal to or below field capacity to decrease runoff.</p> <p><b>LESS RUNOFF</b></p>
<p><b>P2</b></p> <p>Maintenance shots increase runoff, resulting in a decrease in substrate EC.</p> <p><b>DECREASE EC</b></p>	<p><b>P2</b></p> <p>Maintenance shots decrease runoff, resulting in an increase in substrate EC.</p> <p><b>INCREASE EC</b></p>
<p><b>P3</b></p> <p>Small dryback to keep the substrate EC low.</p> <p><b>SMALL DRYBACK</b></p>	<p><b>P3</b></p> <p>Large dryback to keep the substrate EC high.</p> <p><b>LARGE DRYBACK</b></p>

Crop Steering Strategy by Growth Stage		
	GOAL	STRATEGY
<b>Veg</b>	Promote rapid growth of roots, shoots, and leaves	<b>Vegetative Steering</b>
<b>Flower Stretch</b> <small>(weeks 1-4)</small>	Initiate flower formation and decrease internodal spacing (stacking)	<b>Generative Steering</b>
<b>Flower Bulk</b> <small>(weeks 5-7)</small>	Increase Bud Size	<b>Vegetative Steering</b>
<b>Flower Finish</b> <small>(weeks 8-10)</small>	Reduce built up substrate EC and encourage ripening	<b>Vegetative Steering</b> (substrate EC) + <b>Generative Steering</b> (dryback)

Read the entire Directions for Use, Conditions of Warranties, and Limitations of Liability before using this product. If the terms are not acceptable, return the unopened product container at once. By using this product, user or buyer accepts the following Conditions, Disclaimer of Warranties, and Limitations of Liability. CONDITIONS: The directions for use of this product are believed to be adequate and must be followed carefully. However, it is impossible to eliminate all risks associated with the use of this product. Crop injury, ineffectiveness, or other unintended consequences may result because of such factors such as weather conditions, presence of other materials, or the manner of use or application, all of which are beyond the control of Athena Ag, Inc. All such risks shall be assumed by the user or buyer. DISCLAIMER OF WARRANTIES: To the extent consistent with applicable law, Athena Ag, Inc. makes no other warranties, express or implied, of merchantability or of fitness for a particular purpose or otherwise, that extend beyond the statements made on the product's label. No agent of Athena Ag, Inc. is authorized to make any warranties beyond those contained herein or to modify the warranties contained herein. To the extent consistent with applicable law, Athena Ag, Inc. disclaims any liability whatsoever for special, incidental, or consequential damages resulting from the use or handling of this product. LIMITATIONS OF LIABILITY: To the extent consistent with applicable law, the exclusive remedy of the user or buyer for any and all losses, injuries, or damages resulting from the use or handling of this product, whether in contract, warranty, tort, negligence, strict liability or otherwise, shall not exceed the purchase price paid, or at Athena Ag Inc.'s election, the replacement of product.



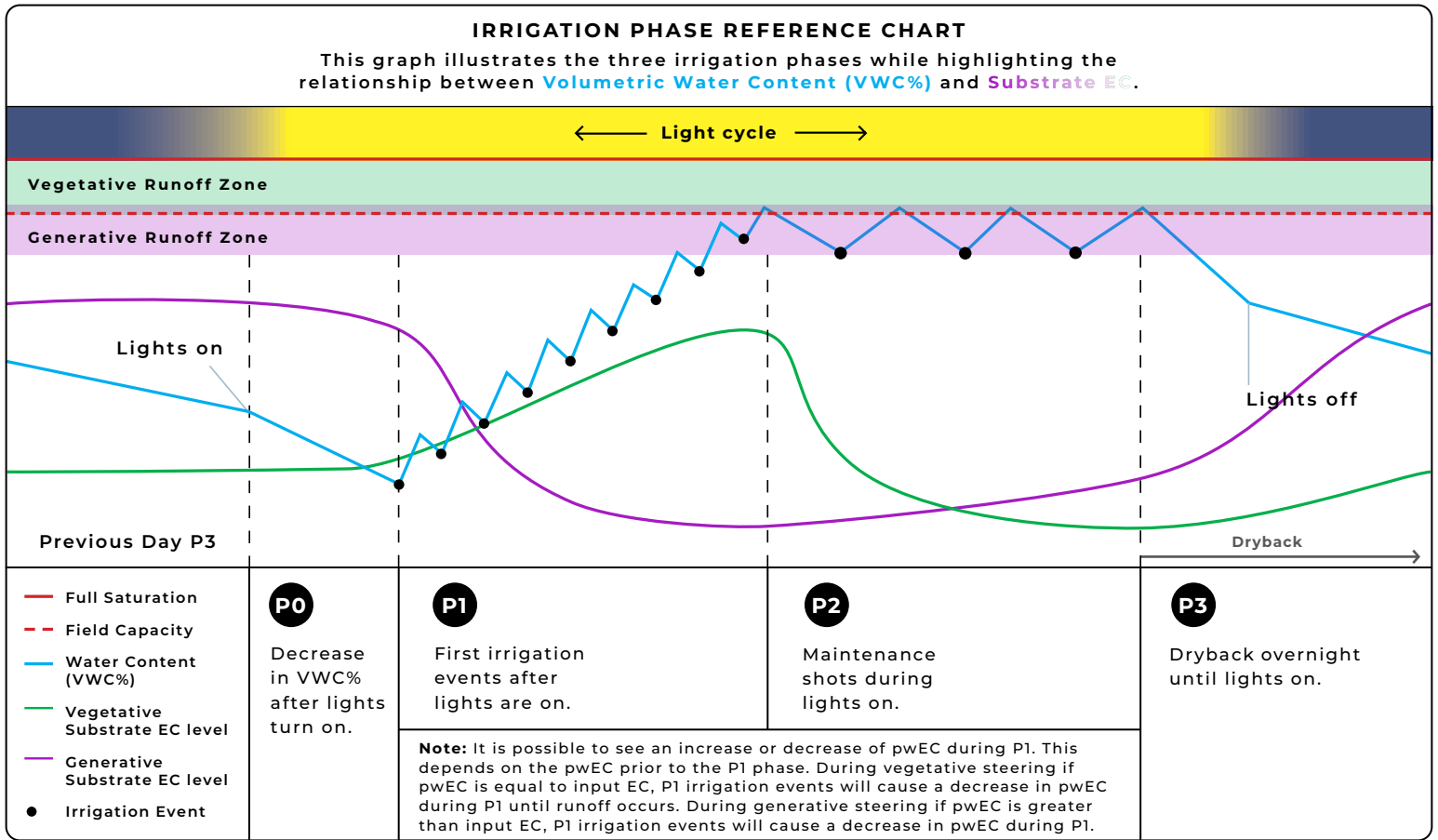

## Veg Irrigation Strategy

During veg, hitting the correct targets becomes crucial to enable our plants to reach their full potential. When transplanting clones into new media, we must be extremely careful to not overwater the substrate. Excess water can lead to stagnant roots and delayed growth. During Veg we will focus solely on the **P1** and **P3** phases because growth is slower and plants transpire less rapidly. After dryback exceeds 20%, introducing **P2** events becomes necessary to maintain optimal substrate moisture.

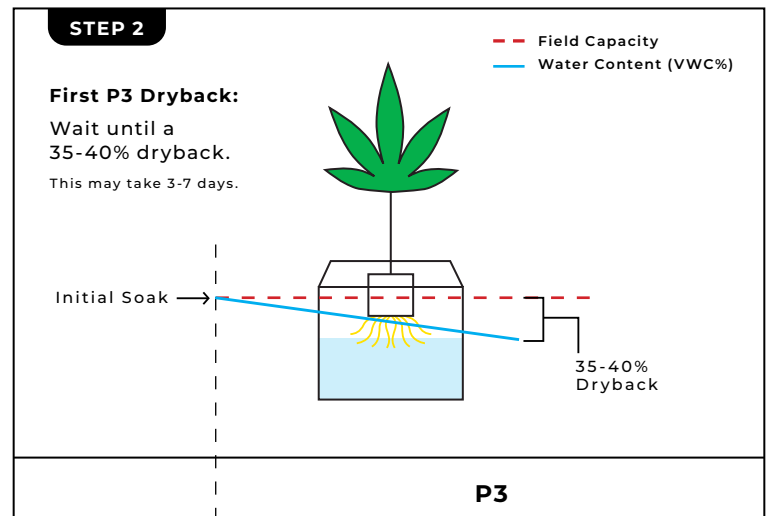
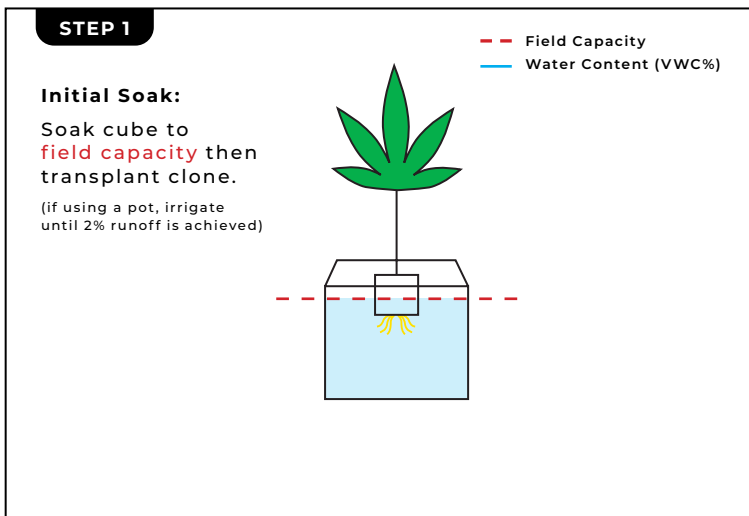

Read the entire Directions for Use, Conditions of Warranties, and Limitations of Liability before using this product. If the terms are not acceptable, return the unopened product container at once. By using this product, user or buyer accepts the following Conditions, Disclaimer of Warranties, and Limitations of Liability. CONDITIONS: The directions for use of this product are believed to be adequate and must be followed carefully. However, it is impossible to eliminate all risks associated with the use of this product. Crop injury, ineffectiveness, or other unintended consequences may result because of such factors such as weather conditions, presence of other materials, or the manner of use or application, all of which are beyond the control of Athena Ag, Inc. All such risks shall be assumed by the user or buyer. DISCLAIMER OF WARRANTIES: To the extent consistent with applicable law, Athena Ag, Inc. makes no other warranties, express or implied, of merchantability or of fitness for a particular purpose or otherwise, that extend beyond the statements made on the product's label. No agent of Athena Ag, Inc. is authorized to make any warranties beyond those contained herein or to modify the warranties contained herein. To the extent consistent with applicable law, Athena Ag, Inc. disclaims any liability whatsoever for special, incidental, or consequential damages resulting from the use or handling of this product. LIMITATIONS OF LIABILITY: To the extent consistent with applicable law, the exclusive remedy of the user or buyer for any and all losses, injuries, or damages resulting from the use or handling of this product, whether in contract, warranty, tort, negligence, strict liability or otherwise, shall not exceed the purchase price paid, or at Athena Ag Inc.'s election, the replacement of product.

**Starting P1 Phase**

This is the first irrigation phase of a lights on cycle until target **VWC%** is reached. The first shot in this phase will occur 1-2 hours after the lights turn on. This will allow the plant's stomata to open and begin to transpire before the media is saturated "transpiration before irrigation." During this phase we will use multiple **2-6% shots** spaced 15-30 mins apart to slowly saturate the media to avoid channeling through the substrate.

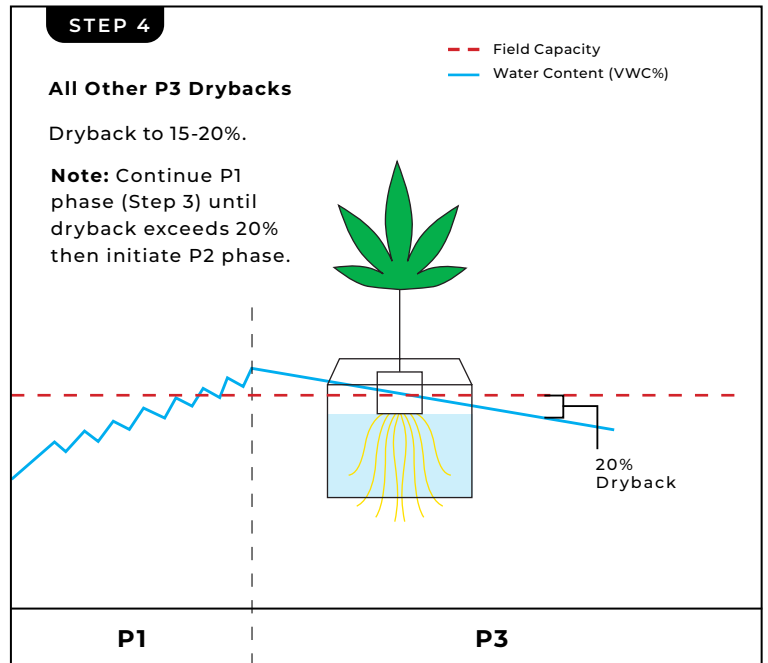
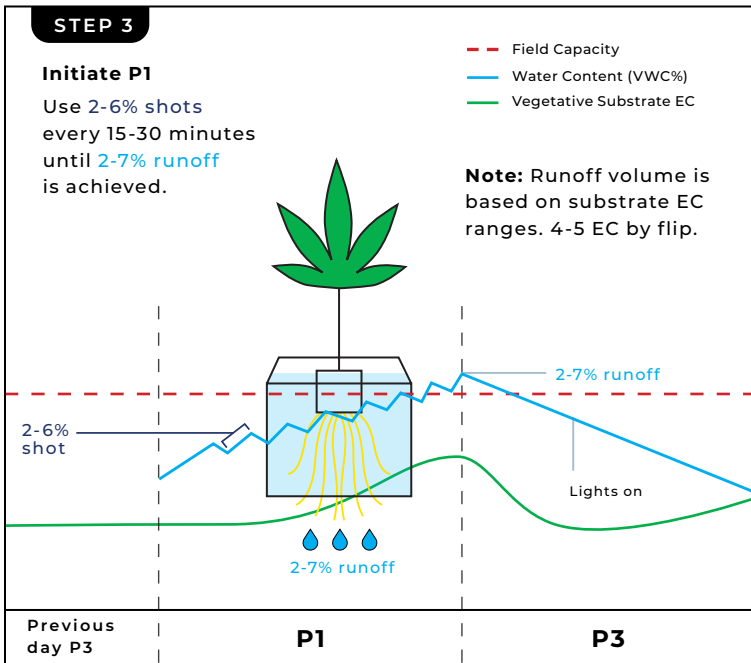
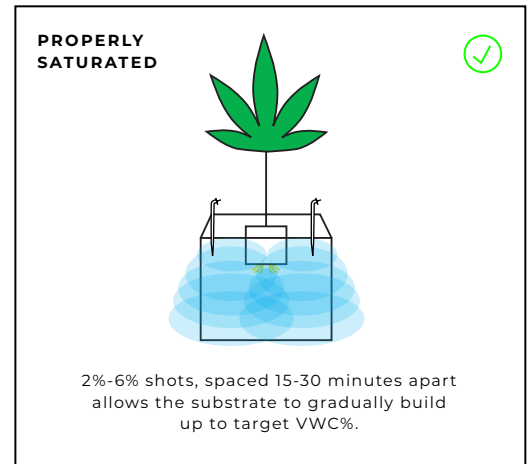
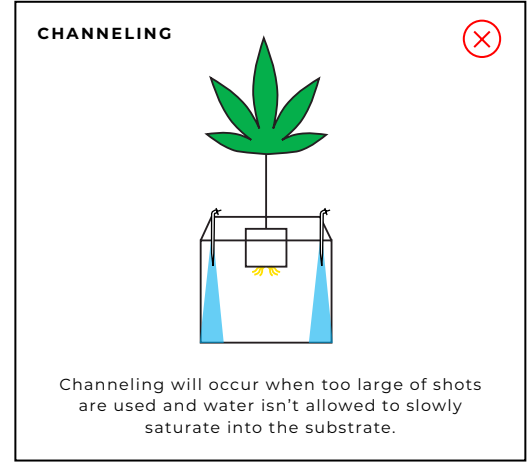
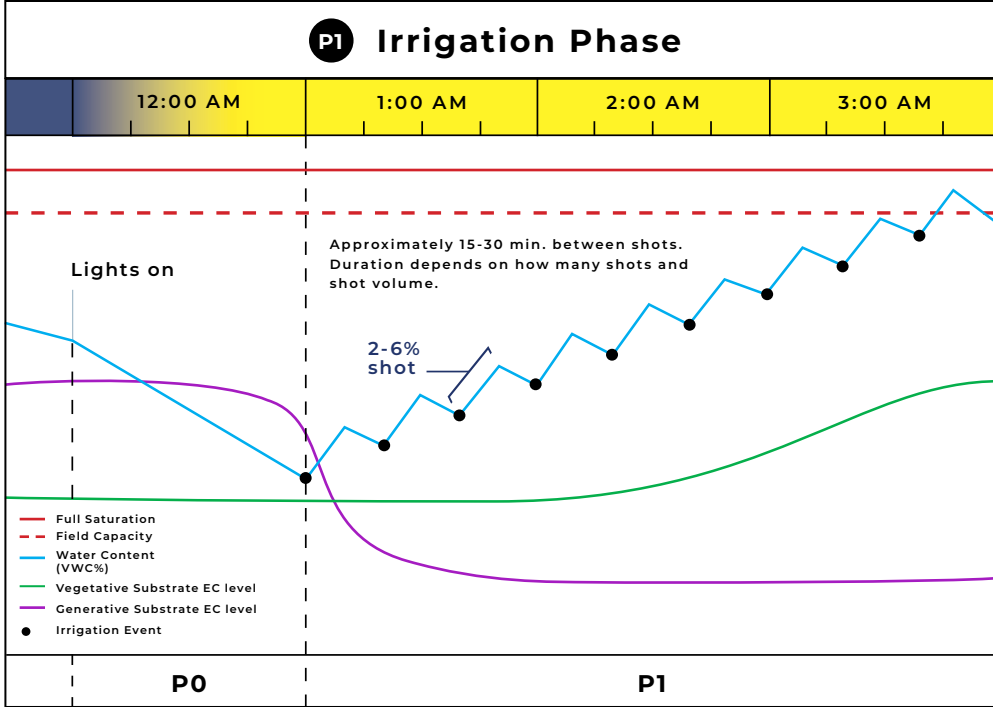

Read the entire Directions for Use, Conditions of Warranties, and Limitations of Liability before using this product. If the terms are not acceptable, return the unopened product container at once. By using this product, user or buyer accepts the following Conditions, Disclaimer of Warranties, and Limitations of Liability. **CONDITIONS:** The directions for use of this product are believed to be adequate and must be followed carefully. However, it is impossible to eliminate all risks associated with the use of this product. Crop injury, ineffectiveness, or other unintended consequences may result because of such factors such as weather conditions, presence of other materials, or the manner of use or application, all of which are beyond the control of Athena Ag, Inc. All such risks shall be assumed by the user or buyer. **DISCLAIMER OF WARRANTIES:** To the extent consistent with applicable law, Athena Ag, Inc. makes no other warranties, express or implied, of merchantability or of fitness for a particular purpose or otherwise, that extend beyond the statements made on the product's label. No agent of Athena Ag, Inc. is authorized to make any warranties beyond those contained herein or to modify the warranties contained herein. To the extent consistent with applicable law, Athena Ag, Inc. disclaims any liability whatsoever for special, incidental, or consequential damages resulting from the use or handling of this product. **LIMITATIONS OF LIABILITY:** To the extent consistent with applicable law, the exclusive remedy of the user or buyer for any and all losses, injuries, or damages resulting from the use or handling of this product, whether in contract, warranty, tort, negligence, strict liability or otherwise, shall not exceed the purchase price paid, or at Athena Ag Inc.'s election, the replacement of product.

P2 Irrigation Phase

The P2 phase is used to maintain a desired VWC% throughout the lights on period. This is the most important phase for controlling substrate EC and dryback. These are the two different ways to control substrate EC and dryback.

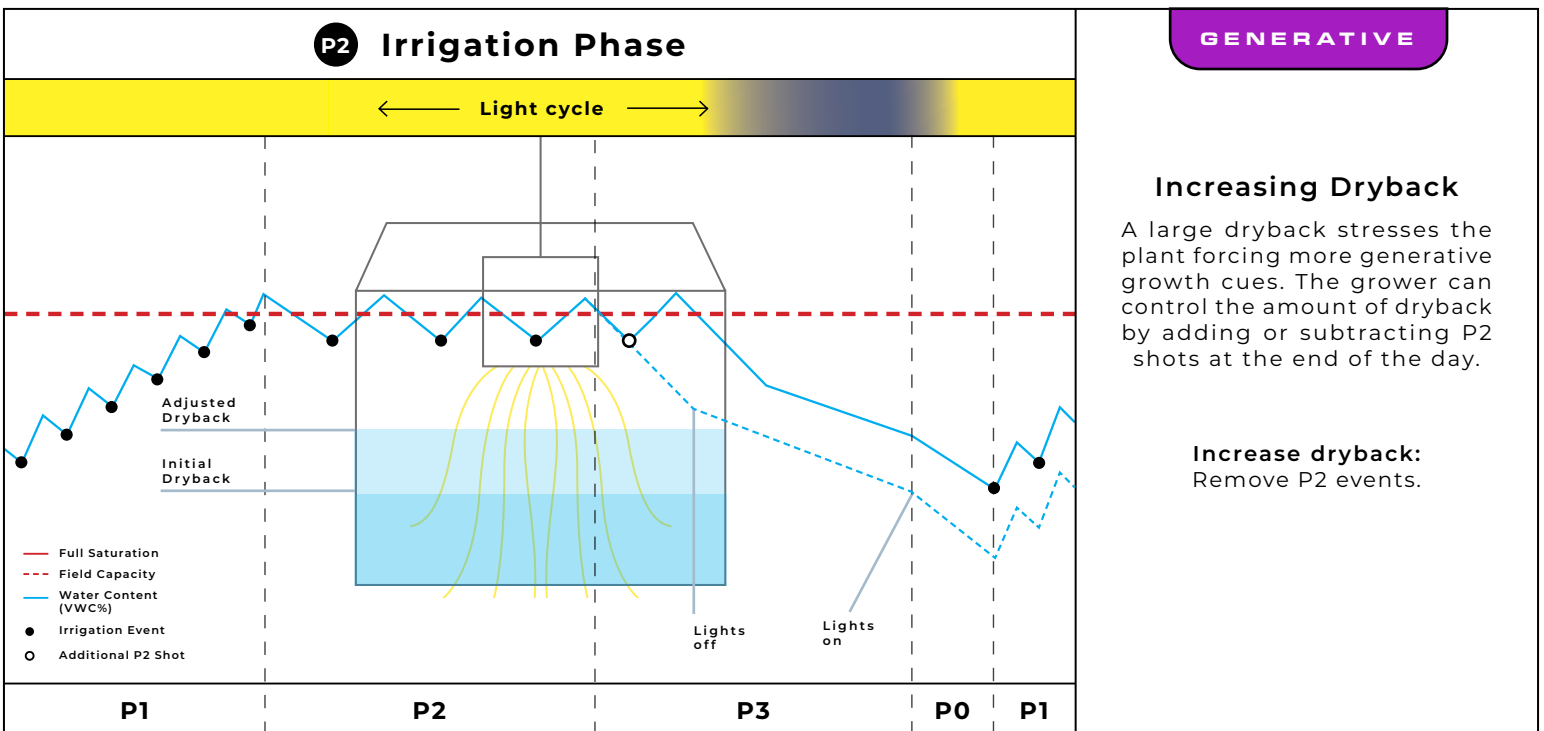
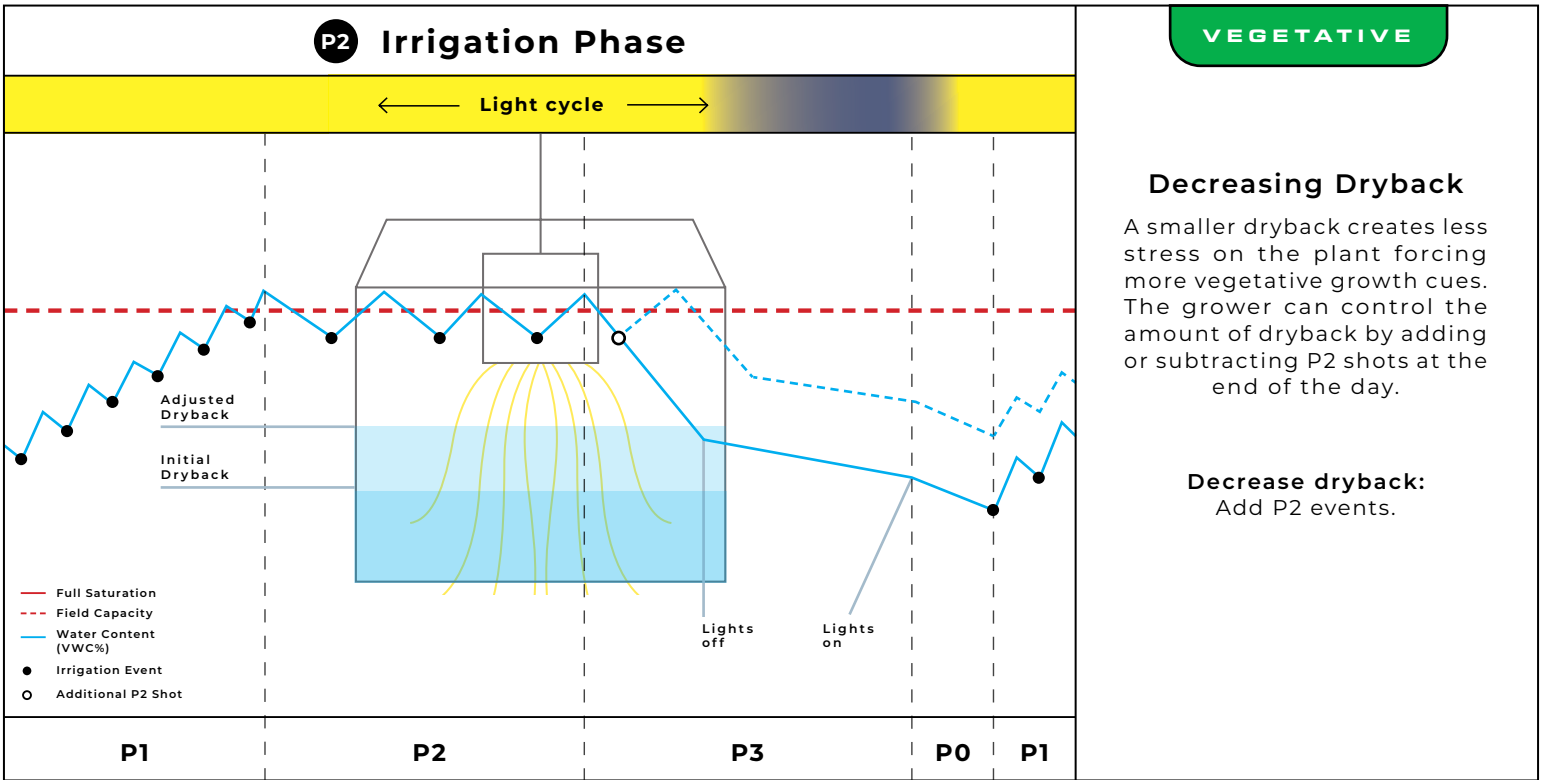

Read the entire Directions for Use, Conditions of Warranties, and Limitations of Liability before using this product. If the terms are not acceptable, return the unopened product container at once. By using this product, user or buyer accepts the following Conditions, Disclaimer of Warranties, and Limitations of Liability. CONDITIONS: The directions for use of this product are believed to be adequate and must be followed carefully. However, it is impossible to eliminate all risks associated with the use of this product. Crop injury, ineffectiveness, or other unintended consequences may result because of such factors such as weather conditions, presence of other materials, or the manner of use or application, all of which are beyond the control of Athena Ag, Inc. All such risks shall be assumed by the user or buyer. DISCLAIMER OF WARRANTIES: To the extent consistent with applicable law, Athena Ag, Inc. makes no other warranties, express or implied, of merchantability or of fitness for a particular purpose or otherwise, that extend beyond the statements made on the product's label. No agent of Athena Ag, Inc. is authorized to make any warranties beyond those contained herein or to modify the warranties contained herein. To the extent consistent with applicable law, Athena Ag, Inc. disclaims any liability whatsoever for special, incidental, or consequential damages resulting from the use or handling of this product. LIMITATIONS OF LIABILITY: To the extent consistent with applicable law, the exclusive remedy of the user or buyer for any and all losses, injuries, or damages resulting from the use or handling of this product, whether in contract, warranty, tort, negligence, strict liability or otherwise, shall not exceed the purchase price paid, or at Athena Ag Inc.'s election, the replacement of product.

**When to add P2 events**

As plants grow and the rate of dryback increases it is now necessary to add P2 events to keep the substrate from drying back too much. Shot size % is determined by substrate size (please refer to the shot volumes chart). The grower can utilize various shot sizes to manipulate substrate EC by controlling the amount of runoff generated. Increasing shot size above the point of field capacity will force more run off causing pwEC to decrease. On the other hand, decreasing shot size slightly above or below field capacity will increase pwEC, this technique is called EC stacking.

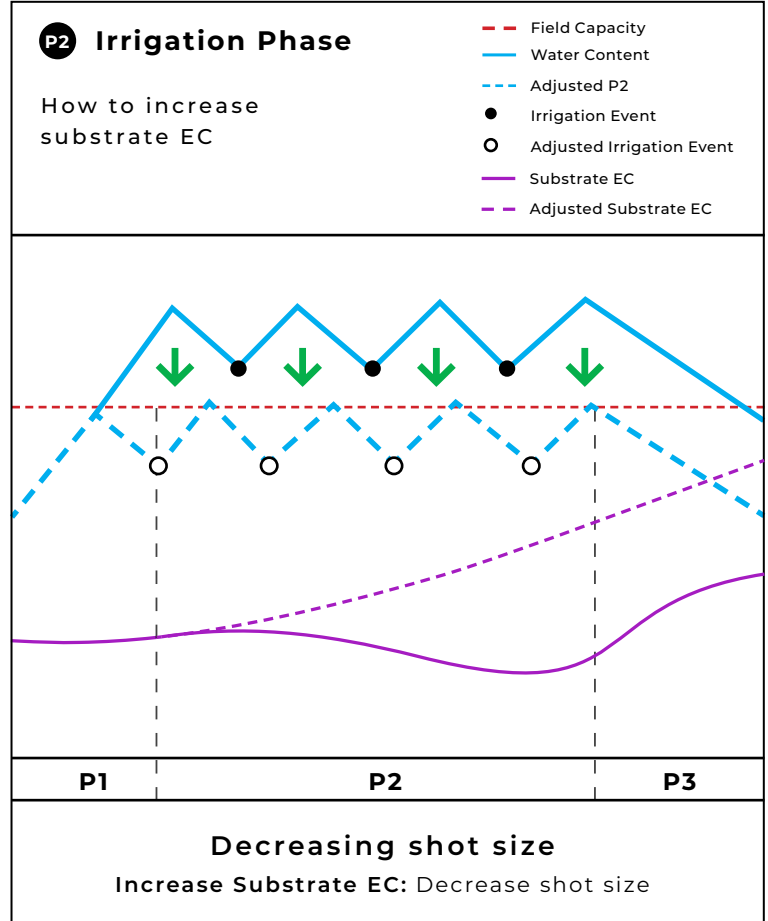
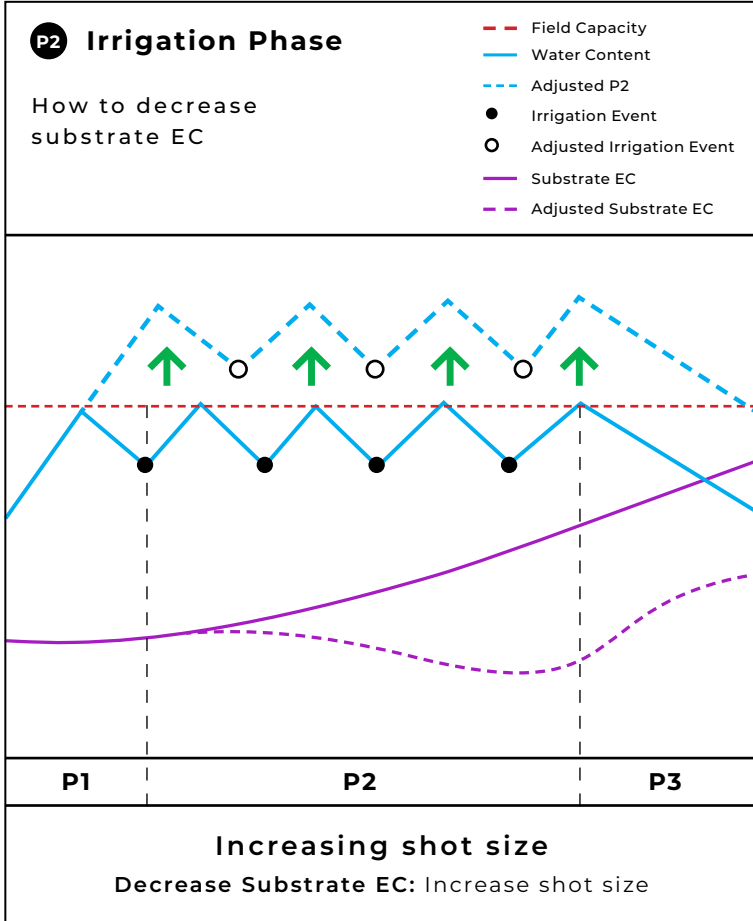

**Irrigation Controller Settings**

It is important to know when to add P2 shots, manage shot size, calculate dryback, and calculate runoff volume. To help plan your irrigation events, scan code to use our Irrigation Strategy Calculator.



**SCAN**  
to access our **Irrigation Strategy Calculator** to help plan your irrigation events using your rate of dryback.

VEGETATIVE	GENERATIVE
LESS STRESS	MORE STRESS
Larger shots ↓ More runoff ↓ Lower substrate EC	Smaller shots ↓ Less runoff ↓ Higher substrate EC

Read the entire Directions for Use, Conditions of Warranties, and Limitations of Liability before using this product. If the terms are not acceptable, return the unopened product container at once. By using this product, user or buyer accepts the following Conditions, Disclaimer of Warranties, and Limitations of Liability. CONDITIONS: The directions for use of this product are believed to be adequate and must be followed carefully. However, it is impossible to eliminate all risks associated with the use of this product. Crop injury, ineffectiveness, or other unintended consequences may result because of such factors such as weather conditions, presence of other materials, or the manner of use or application, all of which are beyond the control of Athena Ag, Inc. All such risks shall be assumed by the user or buyer. DISCLAIMER OF WARRANTIES: To the extent consistent with applicable law, Athena Ag, Inc. makes no other warranties, express or implied, of merchantability or of fitness for a particular purpose or otherwise, that extend beyond the statements made on the product's label. No agent of Athena Ag, Inc. is authorized to make any warranties beyond those contained herein or to modify the warranties contained herein. To the extent consistent with applicable law, Athena Ag, Inc. disclaims any liability whatsoever for special, incidental, or consequential damages resulting from the use or handling of this product. LIMITATIONS OF LIABILITY: To the extent consistent with applicable law, the exclusive remedy of the user or buyer for any and all losses, injuries, or damages resulting from the use or handling of this product, whether in contract, warranty, tort, negligence, strict liability or otherwise, shall not exceed the purchase price paid, or at Athena Ag Inc.'s election, the replacement of product.

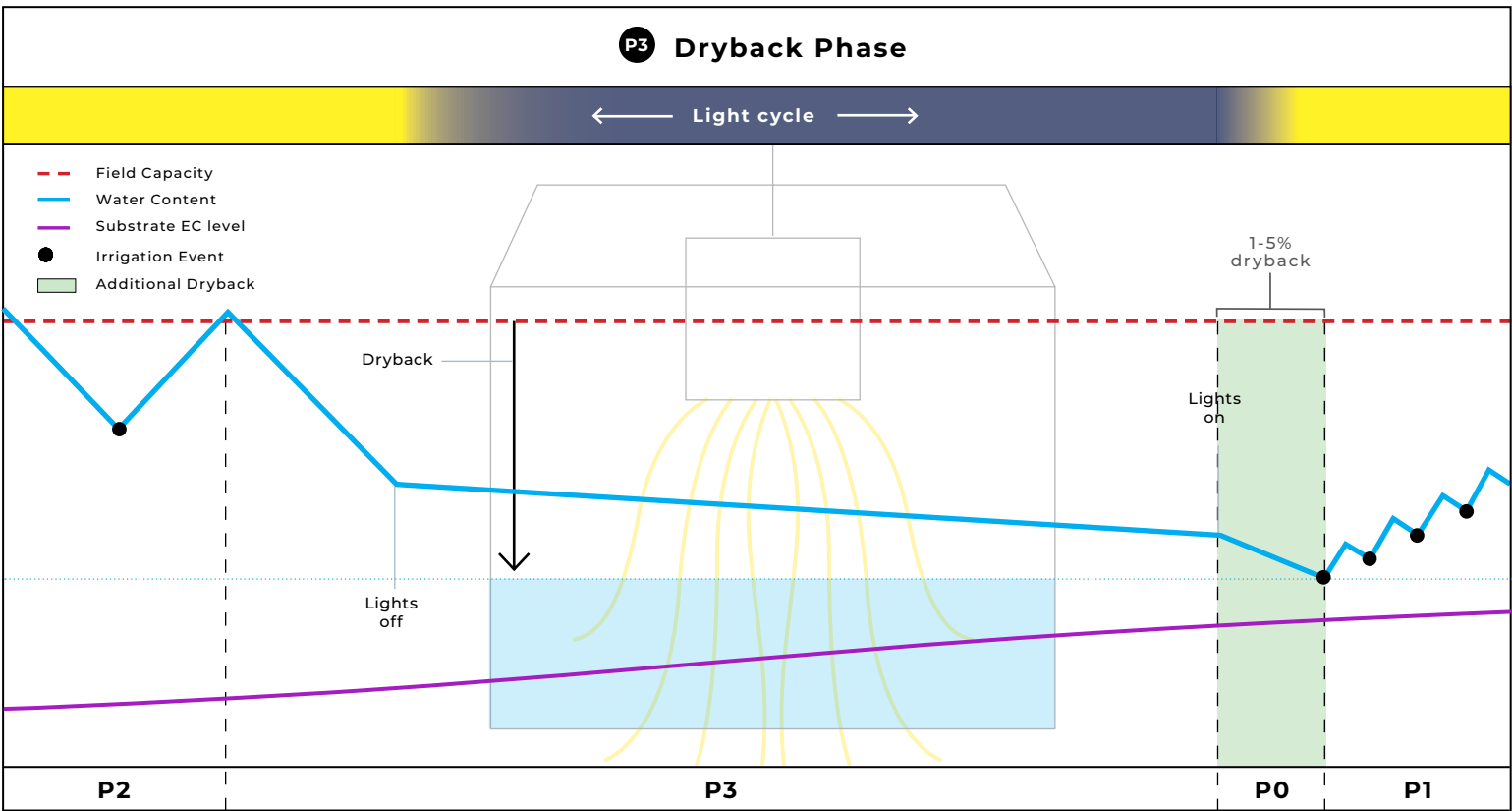

**P3 Irrigation Phase**

This stage will allow the substrate to dry back until the first irrigation event of the following day. Dryback is essential because it lets the roots breathe and avoids issues like root rot, which can happen when the roots stay wet for too long. Additional dryback is 1%-5% dryback after lights are on until first shot 30 mins - 2 hours "Transpiration before irrigation".

Dryback is used to promote **Vegetative** or **Generative** growth.

**Rate of Dryback**

The Rate of Dryback is the difference in VWC% over a period of time. **For example:** If a substrate at Field Capacity measures 50% VWC and one hour later measures at 48% VWC, the Rate of Dryback is 2%/hour, this rate is useful when planning P2 irrigation events and to keep dryback within a desired range. Dryback rate during lights off is also needed to accurately plan irrigation events using our Irrigation Strategy Calculator.



**SCAN**

to access our **Irrigation Strategy Calculator** to help plan your irrigation events using your rate of dryback.

**Note:** Please note that the dryback targets provided here are based on a relative change, whereas some dryback recommendations rely on absolute change. Utilizing relative change is essential for greater accuracy when dealing with substrates that have varying field capacity and full saturation points. This is due to the fact that the change in volumetric water content (VWC%) will be directly proportional to the total volume of solution in the substrate. Understanding which type of measurement is being used is crucial for fine-tuning an exact and effective irrigation strategy.

P3 Dryback Targets	
VEGETATIVE	GENERATIVE
30-40%	40-50%
Less Stress	More Stress
Lengthy Growth/ Bud Swell	Shorter Compact Plants

Read the entire Directions for Use, Conditions of Warranties, and Limitations of Liability before using this product. If the terms are not acceptable, return the unopened product container at once. By using this product, user or buyer accepts the following Conditions, Disclaimer of Warranties, and Limitations of Liability. CONDITIONS: The directions for use of this product are believed to be adequate and must be followed carefully. However, it is impossible to eliminate all risks associated with the use of this product. Crop injury, ineffectiveness, or other unintended consequences may result because of such factors such as weather conditions, presence of other materials, or the manner of use or application, all of which are beyond the control of Athena Ag, Inc. All such risks shall be assumed by the user or buyer. DISCLAIMER OF WARRANTIES: To the extent consistent with applicable law, Athena Ag, Inc. makes no other warranties, express or implied, of merchantability or of fitness for a particular purpose or otherwise, that extend beyond the statements made on the product's label. No agent of Athena Ag, Inc. is authorized to make any warranties beyond those contained herein or to modify the warranties contained herein. To the extent consistent with applicable law, Athena Ag, Inc. disclaims any liability whatsoever for special, incidental, or consequential damages resulting from the use or handling of this product. LIMITATIONS OF LIABILITY: To the extent consistent with applicable law, the exclusive remedy of the user or buyer for any and all losses, injuries, or damages resulting from the use or handling of this product, whether in contract, warranty, tort, negligence, strict liability or otherwise, shall not exceed the purchase price paid, or at Athena Ag Inc.'s election, the replacement of product.

Follow us on Instagram!

@Athena.Ag

A01.002

AthenaAg.com

### Determining Target Runoff

Once **Full Saturation** is reached, **VWC%** will remain constant. Any additional water added to the substrate at **Full Saturation** will be drained and will not increase **VWC%**.

Determining the **VWC%** at the *point of runoff* is crucial to manipulating substrate EC by controlling the volume of runoff produced by irrigation events. The grower must strategically determine a target **VWC%** while considering **VWC%** at **Field Capacity** and **Full Saturation**. Setting a target **VWC%** above the point of **Full Saturation** will cause excessive runoff and is a target that is impossible to reach.

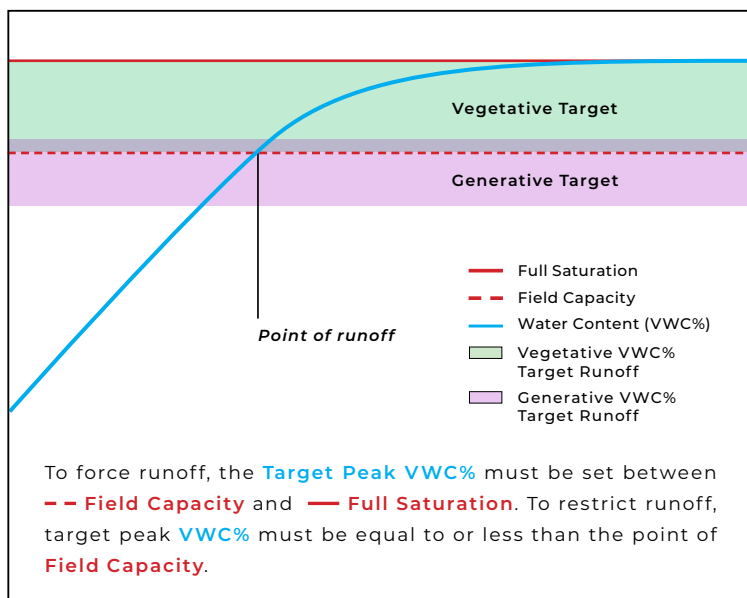

**PRO TIP:** Have an extra set of emitters placed in a pitcher to catch irrigation water to monitor shot volume.

SHOT VOLUMES	
Substrate Size	1% Shot volume
4 Liter Pot	40 mL
7 Liter Pot	70 mL
10 Liter Pot	100 mL
10 cm Rockwool (Delta 6.5)	6.5 mL
10 cm Rockwool (Delta 10)	10 mL
15 cm Rockwool (Hugo)	35 mL
Uni-Slab Rockwool	50 mL
15 cm Rockwool Slab	100 mL

Runoff Targets Based on Substrate Size		
By adjusting our shot sizes to increase or decrease the volume of runoff, we can precisely control and fine-tune the substrate EC.		
Substrate Size	Vegetative Runoff Volume (8% - 16%)	Generative Runoff Volume (1% - 7%)
4 Liter Pot	320 mL - 640 mL	40 mL - 280 mL
7 Liter Pot	560 mL - 1,120 mL	70 mL - 490 mL
10 Liter Pot	800 mL - 1,600 mL	100 mL - 700 mL
10 cm Rockwool (Delta 6.5)	56 mL - 112 mL	7 mL - 46 mL
10 cm Rockwool (Delta 10)	80 mL - 160 mL	10 mL - 70 mL
15 cm Rockwool (Hugo)	280 mL - 560 mL	35 mL - 245 mL

SUBSTRATE EC RANGE			
Veg	Flower Stretch	Flower Bulk	Flower Finish
3 - 5	4 - 10	3.5 - 6	0.5 - 4
These EC values are when substrate is at peak VWC%			

IRRIGATION STRATEGY TARGETS				
Growth Stages	Veg	Flower Stretch	Flower Bulk	Flower Finish
Weeks	2 - 4	1 - 4	5 - 7	8 - 9
pwEC	3 - 5	4 - 10	3.5 - 6	3 - 4
Runoff	25%+	15%+	30%+	30%+
Dryback	50% initial, 25% all following	40% - 50%	30% - 40%	40% - 50%
Strategy	Vegetative	Generative	Vegetative	Vegetative pwEC, Generative dryback

Read the entire Directions for Use, Conditions of Warranties, and Limitations of Liability before using this product. If the terms are not acceptable, return the unopened product container at once. By using this product, user or buyer accepts the following Conditions, Disclaimer of Warranties, and Limitations of Liability. CONDITIONS: The directions for use of this product are believed to be adequate and must be followed carefully. However, it is impossible to eliminate all risks associated with the use of this product. Crop injury, ineffectiveness, or other unintended consequences may result because of such factors such as weather conditions, presence of other materials, or the manner of use or application, all of which are beyond the control of Athena Ag, Inc. All such risks shall be assumed by the user or buyer. DISCLAIMER OF WARRANTIES: To the extent consistent with applicable law, Athena Ag, Inc. makes no other warranties, express or implied, of merchantability or of fitness for a particular purpose or otherwise, that extend beyond the statements made on the product's label. No agent of Athena Ag, Inc. is authorized to make any warranties beyond those contained herein or to modify the warranties contained herein. To the extent consistent with applicable law, Athena Ag, Inc. disclaims any liability whatsoever for special, incidental, or consequential damages resulting from the use or handling of this product. LIMITATIONS OF LIABILITY: To the extent consistent with applicable law, the exclusive remedy of the user or buyer for any and all losses, injuries, or damages resulting from the use or handling of this product, whether in contract, warranty, tort, negligence, strict liability or otherwise, shall not exceed the purchase price paid, or at Athena Ag Inc.'s election, the replacement of product.

**Runoff Procedure**

**CAUTION:** MAKE SURE TO MONITOR THE DRYBACKS IN LARGER PLANTS TO AVOID DRYING BACK PAST WILTING POINT.

<b>1 Select</b>	Before P1 Irrigation Phase begins, select 2-3 average size plants within each irrigation zone. This will give the best representation of the average runoff for plants within the zone.
<b>2 Place</b>	Place each selected plant on top of a clone tray with insert. This will allow plants to freely drain into the tray without sitting in runoff.
<b>3 Irrigate</b>	Allow P1 and P2 irrigation phases to run as normal.
<b>4 Collect</b>	Collect runoff from each tray immediately after the P2 irrigation phase ends to avoid loss of water due to evaporation.
<b>5 Measure</b>	Measure volume of runoff in a graduated cylinder.
<b>6 Test</b>	Using a calibrated EC and pH meter, test runoff EC and pH.
<b>7 Compare</b>	Compare runoff EC to substrate EC on substrate sensor to validate accuracy of substrate sensor. Runoff EC tends to be slightly lower than substrate EC.
<b>8 Adjust</b>	Refer to the runoff and substrate EC ranges charts in precision irrigation strategy procedure and adjust irrigation events accordingly to keep substrate EC within the correct range based on growth stage.
<b>9 pH</b>	Based on runoff pH adjust input nutrient solution pH to bring substrate pH within the correct range.  <b>Note:</b> The runoff pH should be slightly higher than the input nutrient solution pH to indicate a healthy developing plant. A lower runoff pH indicates that the plant is having problems using the nutrients within the rootzone. The lower pH usually happens when the rootzone is too wet and roots are sitting in too much moisture and rot.

**PRO TIP:** To ensure an accurate sensor reading, pack the coco tightly around the sensor to avoid air pockets.

Substrate Sensor Placement			
4 L Pot	7 L Pot	10 L Pot	Rockwool
2.5 cm from bottom	5 cm from bottom	5 cm from bottom	2.5 cm from bottom

**Irrigation Zone Sensor Placement**

Plants positioned in different areas within an irrigation zone experience different rates of dryback due to variations in environmental variables such as temperature and airflow. For example plants next to a fan or an isle would have an increased rate of dryback as opposed to plants in the center of an irrigation zone.

When choosing the best location for a substrate sensor to control an irrigation zone it is crucial to select a plant that best represents the average moisture level of all the plants within the zone. For larger irrigation zones, it may be required to utilize multiple sensors placed in different areas to dial in your irrigation strategy. Depending on the irrigation controller additional sensors may be used as supplemental data or may be used to take average readings.

**PRO TIP:** Designate individual strains to specific irrigation zones due to varying rates of dryback.

The image below shows the variance in VWC% that can be seen in different areas of the irrigation zone based on environmental factors within a grow room.

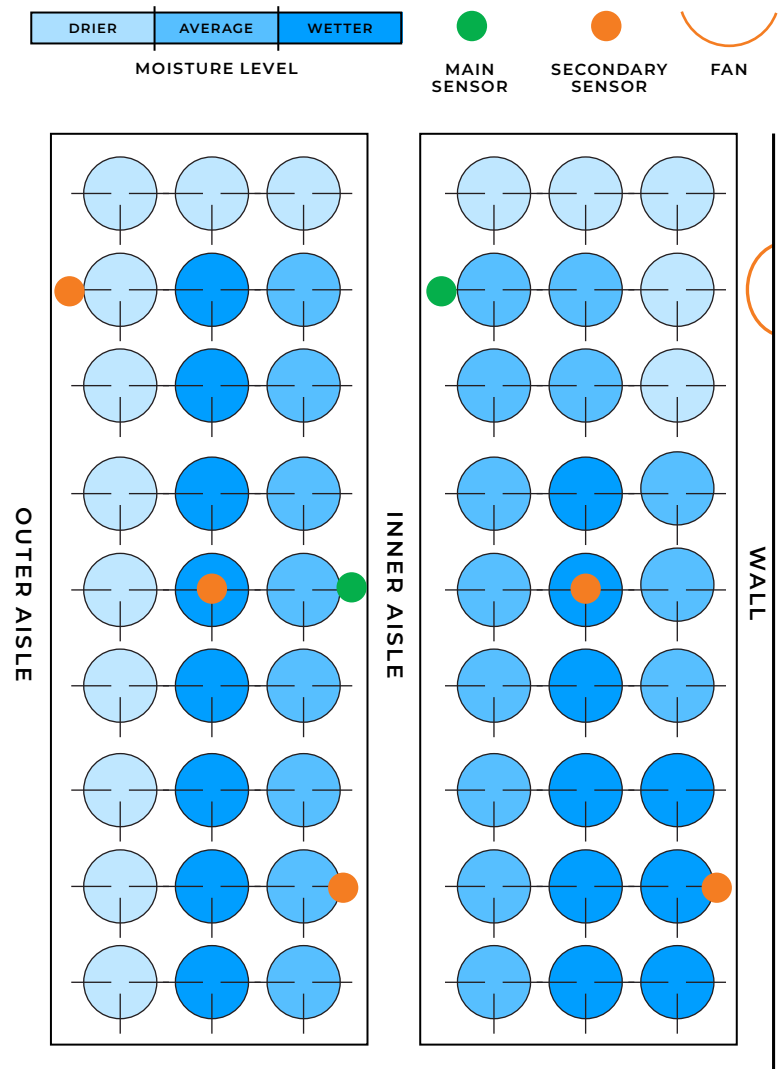

Read the entire Directions for Use, Conditions of Warranties, and Limitations of Liability before using this product. If the terms are not acceptable, return the unopened product container at once. By using this product, user or buyer accepts the following Conditions, Disclaimer of Warranties, and Limitations of Liability. CONDITIONS: The directions for use of this product are believed to be adequate and must be followed carefully. However, it is impossible to eliminate all risks associated with the use of this product. Crop injury, ineffectiveness, or other unintended consequences may result because of such factors such as weather conditions, presence of other materials, or the manner of use or application, all of which are beyond the control of Athena Ag, Inc. All such risks shall be assumed by the user or buyer. DISCLAIMER OF WARRANTIES: To the extent consistent with applicable law, Athena Ag, Inc. makes no other warranties, express or implied, of merchantability or of fitness for a particular purpose or otherwise, that extend beyond the statements made on the product's label. No agent of Athena Ag, Inc. is authorized to make any warranties beyond those contained herein or to modify the warranties contained herein. To the extent consistent with applicable law, Athena Ag, Inc. disclaims any liability whatsoever for special, incidental, or consequential damages resulting from the use or handling of this product. LIMITATIONS OF LIABILITY: To the extent consistent with applicable law, the exclusive remedy of the user or buyer for any and all losses, injuries, or damages resulting from the use or handling of this product, whether in contract, warranty, tort, negligence, strict liability or otherwise, shall not exceed the purchase price paid, or at Athena Ag Inc.'s election, the replacement of product.



Pro Line Feed/Runoff Targets													
	VEG				FLOWER								
	W1	W2	W3	W4	W1	W2	W3	W4	W5	W6	W7	*W8	**W9/ Flush
EC	3.0	3.0	3.0	3.0	3.0	3.0	3.0	3.0	3.0	3.0	3.0	3.0	0.0 - 1.0
PH	5.8 - 6.2	5.8 - 6.2	5.8 - 6.2	5.8 - 6.2	5.9 - 6.3	5.9 - 6.3	5.9 - 6.3	5.9 - 6.3	5.9 - 6.3	5.9 - 6.3	5.9 - 6.3	5.9 - 6.3	5.9 - 6.3
RUNOFF TARGET EC	4.0 - 5.0	4.0 - 5.0	4.0 - 5.0	4.0 - 5.0	6.0 - 7.0	6.0 - 7.0	6.0 - 7.0	5.0 - 6.0	5.0 - 6.0	5.0 - 6.0	4.0 - 5.0	3.0 - 3.5	0.0 - 1.0
RUNOFF TARGET PH	5.8 - 6.2	5.8 - 6.2	5.8 - 6.2	5.8 - 6.2	5.9 - 6.3	5.9 - 6.3	5.9 - 6.3	5.9 - 6.3	5.9 - 6.3	5.9 - 6.3	5.9 - 6.3	5.9 - 6.3	5.9 - 6.3
DRYBACK TARGET	30% - 40% WC	30% - 40% WC	30% - 40% WC	30% - 40% WC	30% - 40% WC	50% - 60% WC	50% - 60% WC	30% - 40% WC	30% - 40% WC	30% - 40% WC	30% - 40% WC	50% - 60% WC	50% - 60% WC

## MONITORING DRYBACK

The key is having your substrate dryback overnight to the targeted percentage.

You can monitor drybacks by:

<b>1</b>		<b>2</b>	
	Picking up each pot before feeding to make a judgement call on how dry the substrate is.		Use a water content meter to monitor how much water is in the substrate.

Strive for one feed each morning with roughly 10-25% runoff when the lights come on. Aim for the substrate to dry back over a 24 hour period. This dryback period is very important to allow for optimal root development.

**WARNING: IF THE SUBSTRATE IS NOT DRYING BACK BY MORNING, YOU NEED TO LET IT DRYBACK BEFORE FEEDING TO AVOID OVERWATERING ISSUES.**

The goal is to have the whole garden feeding and drying back consistently every day.	You <b>DO NOT</b> want a situation where you're hand feeding multiple times per day.

## CHECKING RUNOFF

Monitor the runoff and make adjustments for the next feeding (if needed) based on runoff EC/pH and plant health. You want to be within +/- 1 EC of suggested runoff targets and within +/- 10% of dryback targets.

If you run more water through the substrate, there will be lower EC in the substrate.



3-3.5 Week Veg – 6 plants per 1.2mx1.2m/1.5mx1.5m area

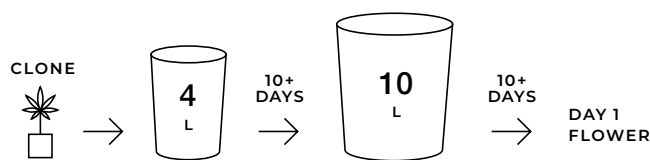

4-5 Week Veg – 4 plants per 1.2mx1.2m/1.5mx1.5m area

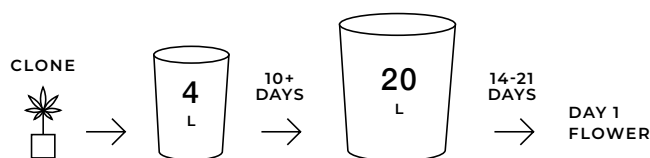

Read the entire Directions for Use, Conditions of Warranties, and Limitations of Liability before using this product. If the terms are not acceptable, return the unopened product container at once. By using this product, user or buyer accepts the following Conditions, Disclaimer of Warranties, and Limitations of Liability. CONDITIONS: The directions for use of this product are believed to be adequate and must be followed carefully. However, it is impossible to eliminate all risks associated with the use of this product. Crop injury, ineffectiveness, or other unintended consequences may result because of such factors such as weather conditions, presence of other materials, or the manner of use or application, all of which are beyond the control of Athena Ag, Inc. All such risks shall be assumed by the user or buyer. DISCLAIMER OF WARRANTIES: To the extent consistent with applicable law, Athena Ag, Inc. makes no other warranties, express or implied, of merchantability or of fitness for a particular purpose or otherwise, that extend beyond the statements made on the product's label. No agent of Athena Ag, Inc. is authorized to make any warranties beyond those contained herein or to modify the warranties contained herein. To the extent consistent with applicable law, Athena Ag, Inc. disclaims any liability whatsoever for special, incidental, or consequential damages resulting from the use or handling of this product. LIMITATIONS OF LIABILITY: To the extent consistent with applicable law, the exclusive remedy of the user or buyer for any and all losses, injuries, or damages resulting from the use or handling of this product, whether in contract, warranty, tort, negligence, strict liability or otherwise, shall not exceed the purchase price paid, or at Athena Ag Inc.'s election, the replacement of product.

Follow us on Instagram!



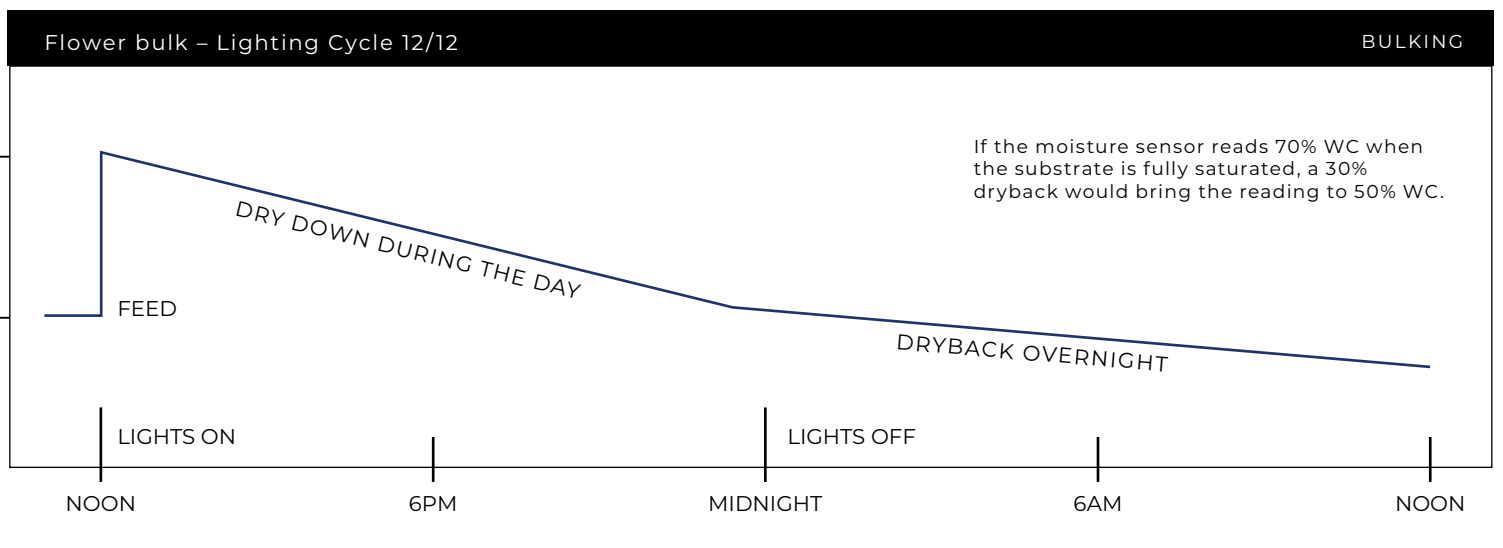
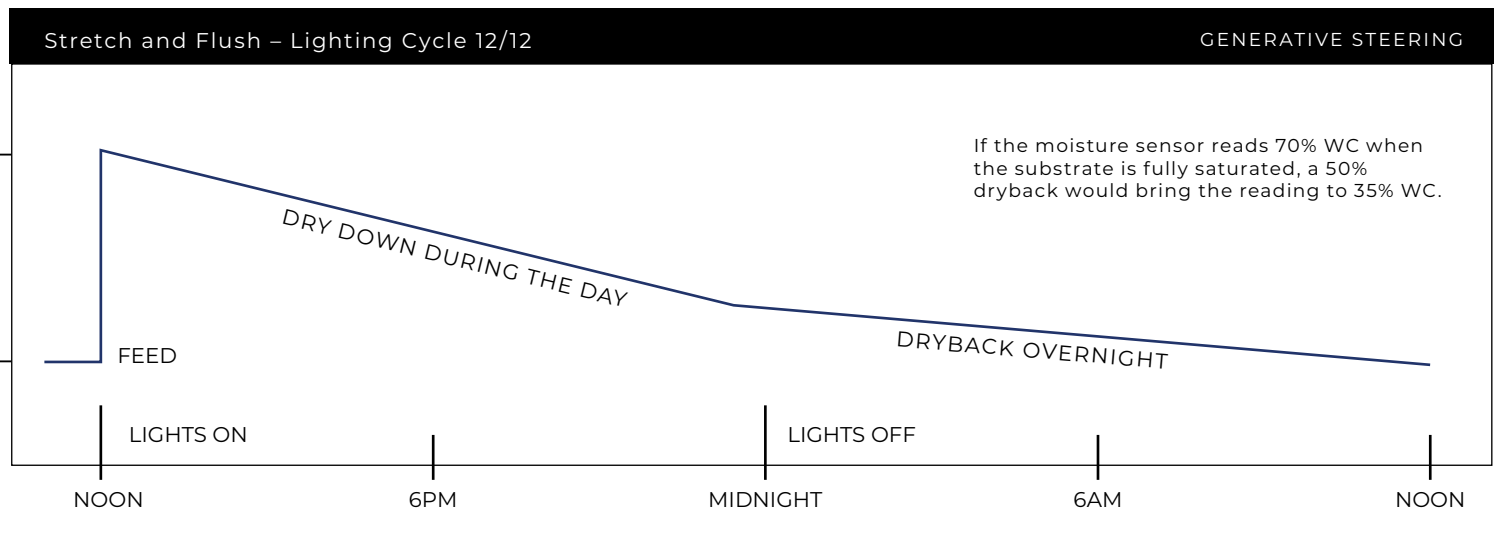
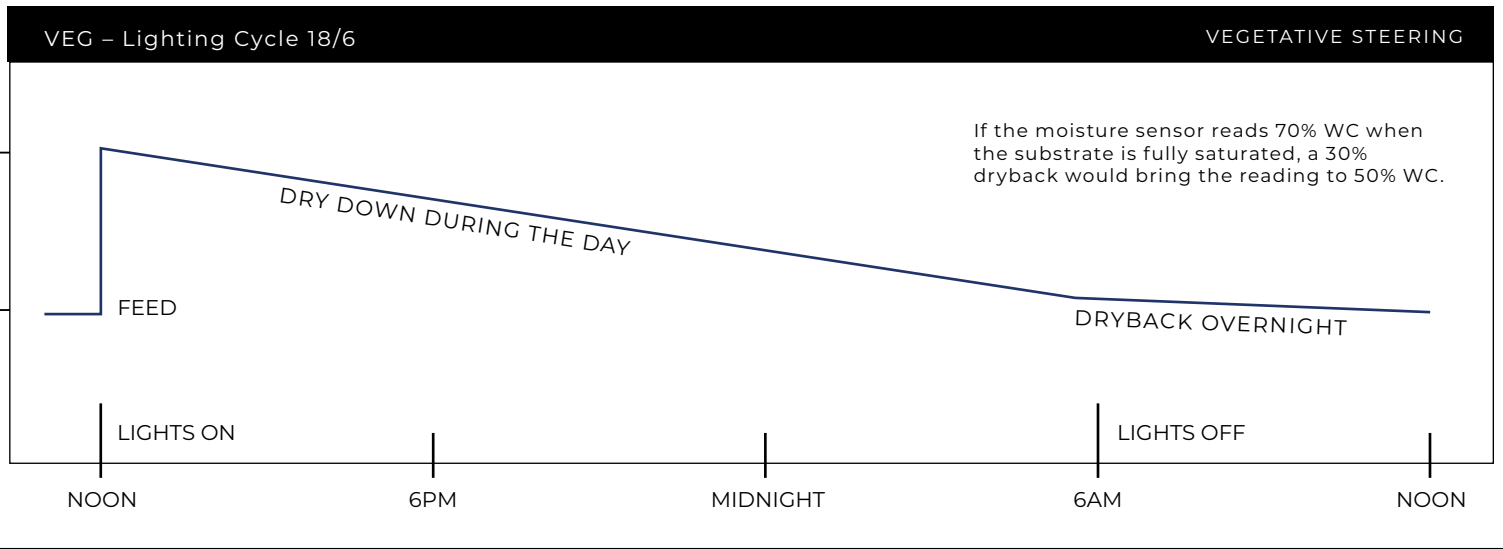

Read the entire Directions for Use, Conditions of Warranties, and Limitations of Liability before using this product. If the terms are not acceptable, return the unopened product container at once. By using this product, user or buyer accepts the following Conditions, Disclaimer of Warranties, and Limitations of Liability. **CONDITIONS:** The directions for use of this product are believed to be adequate and must be followed carefully. However, it is impossible to eliminate all risks associated with the use of this product. Crop injury, ineffectiveness, or other unintended consequences may result because of such factors as weather conditions, presence of other materials, or the manner of use or application, all of which are beyond the control of Athena Ag, Inc. All such risks shall be assumed by the user or buyer. **DISCLAIMER OF WARRANTIES:** To the extent consistent with applicable law, Athena Ag, Inc. makes no other warranties, express or implied, of merchantability or of fitness for a particular purpose or otherwise, that extend beyond the statements made on the product's label. No agent of Athena Ag, Inc. is authorized to make any warranties beyond those contained herein or to modify the warranties contained herein. To the extent consistent with applicable law, Athena Ag, Inc. disclaims any liability whatsoever for special, incidental, or consequential damages resulting from the use or handling of this product. **LIMITATIONS OF LIABILITY:** To the extent consistent with applicable law, the exclusive remedy of the user or buyer for any and all losses, injuries, or damages resulting from the use or handling of this product, whether in contract, warranty, tort, negligence, strict liability or otherwise, shall not exceed the purchase price paid, or at Athena Ag Inc's election, the replacement of product.

Follow us on Instagram!

@Athena.Ag

A01.002

AthenaAg.com

**ATHENA**<sup>®</sup>

# CHECKING RUN-OFF STEP-BY-STEP



(Please refer to **Pro Line Hand Water** Irrigation Strategy on page 42 and **Blended Line Hand Water** Irrigation Strategy on page 60)





**1** Collect the run-off solution in a sterilized container.



**2** Place a calibrated EC and pH meter in the measuring cup to get a reading.



**PRO TIP:** Runoff can also be collected at the drain from a full tray of plants.



**NOTE:** EC stands for Electrical Conductivity. This measures salt concentration in a fertilizer or substrate, indicating the amount of ions available to plants. The EC value rises between each feeding as the media dries. When EC rises, roots can become more susceptible to being burnt. Manage your runoff to correlate to the specific growth stage of your plant.

**NOTE:** Lower pH runoff conversely is an indication that there are problems in the rootzone. In general low pH runoff indicates that the plant is having problems using the nutrients in the rootzone. The lower pH runoff usually happens when the rootzone is too wet and roots are sitting in too much moisture and rot.

### CHECKING EC



Target runoff EC should be 1 -2 EC over what your input EC is depending on stage of growth. (Please refer to [Pro Line Hand Water Irrigation Strategy](#) on page 34 and [Blended Line Hand Water Irrigation Strategy](#) on page 54)

### CHECKING PH



The pH should be higher in runoff than the input solution to indicate a healthy developing plant. (Please refer to [Pro Line Hand Water Irrigation Strategy](#) on page 34 and [Blended Line Hand Water Irrigation Strategy](#) on page 54)



14-16 DAYS



# Clone Recipe

Pro Line is grams per 10 L, Cleanse is mL per 10 L.

MIXING ORDER	CLONE
Balance	<p><b>Use as pH up</b></p> <p><b>Balance:</b> Recommended for batch tank mixing and Dosatron. Do not use with Netaflex.</p> <p><b>Pro Balance:</b> Recommended for advanced irrigation systems like Netaflex.</p>
Pro Balance	
Pro Bloom	12.9
Pro Core	7.7
Cleanse	3
EC	2.0
PPM 500	1000
PPM 700	1400
pH	5.6



**The Perfect Run.™**

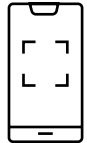

**SCAN ME**

Scan code for access to our most current in-depth **Feed Schedules** and **Procedures.**





2-3 MONTHS



(Mom Feed + Cup Solution)



# Mother & Veg Recipe

Pro Line is grams per 10 L, Cleanse is mL per 10 L.

MIXING ORDER	VEG
Balance	Use as pH up Balance: Recommended for batch tank mixing and Dosatron. Do not use with Netaflex. Pro Balance: Recommended for advanced irrigation systems like Netaflex.
Pro Balance	
Pro Grow	20.3
Pro Core	12.2
Cleanse	5 - 13
EC	3.0
PPM 500	1500
PPM 700	2100
pH	5.8-6.2 (Coco/Rockwool) 6.0-6.4 (Peat-based mediums)



The Perfect Run.™

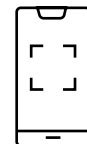

**SCAN ME**

Scan code for access to our most current in-depth **Feed Schedules** and **Procedures**.





WEEKS 1-7



# Flower Recipe

Pro Line is grams per 10 L, Cleanse is mL per 10 L.

MIXING ORDER	FLOWER
Balance	Use as pH up <b>Balance:</b> Recommended for batch tank mixing and Dosatron. Do not use with Netaflex. <b>Pro Balance:</b> Recommended for advanced irrigation systems like Netaflex.
Pro Balance	
Pro Bloom	20.3
Pro Core	12.2
Cleanse	5 - 13
EC	3.0
PPM 500	1500
PPM 700	2100
pH	5.8-6.2 (Coco/Rockwool) 6.0-6.4 (Peat-based mediums)



The Perfect Run.™

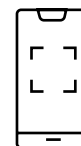

**SCAN ME**

Scan code for access to our most current in-depth **Feed Schedules** and **Procedures**.







LAST 2 WEEKS



# Finish Recipe

Pro Line is grams per 10 L, Cleanse & Fade is mL per 10 L.

MIXING ORDER	FLOWER
Balance	<b>Use as pH up</b> Balance: Recommended for batch tank mixing and Dosatron. Do not use with Netaflex. Pro Balance: Recommended for advanced irrigation systems like Netaflex.
Pro Balance	
Pro Bloom	20.3
Fade	51
Cleanse	5 - 13
EC	3.0
PPM 500	1500
PPM 700	2100
pH	5.8-6.2 (Coco/Rockwool) 6.0-6.4 (Peat-based mediums)

**The Perfect Run.™**

**SCAN ME**

Scan code for access to our most current in-depth **Feed Schedules** and **Procedures.**



PRO 

# CANNABIS CUP WINS





@rkive.cultivation

- 1ST Best Overall
- 1ST Best Tasting



@ghostbudstersfarm

- 1ST Best Looking
- 2ND Best Terps



@growmarket.ch

- 1ST Indoor Flower



@tricomagoldgems

- 1ST Sativa



@bigbangcreations\_

- 1ST Over All Popular Vote
- 2ND Indica



@mohaveco

- 1ST Best Cultivation
- 2ND Best Sativa
- 2ND Best Indica



@lazyriverproducts\_cultivation

- 2ND Sativa Flower



@idealcc\_ma

- 1ST Indica Flower



@michiganderfire

- 3RD Best Terps
- 3RD Best Tasting

@soilless\_media

Smoking Good Extractions  
Smoking Good Farms

- 1ST Hybrid
- 1ST Sativa
- 2ND Indica

@stonerandco

NECANN CUP

NECANN

- 1ST Flower
- 1ST Preroll

@michiganderfire

ZA LYMPHIX

- 1ST Best Terps

@fiore

ZA LYMPHIX

- 1ST Best Looking Flower

@hiddengroupgenetics

SPANABIS CHAMPIONS CUP

hace entrega de 1.000 € por la categoría Sativa CUP

SPANABIS CHAMPIONS CUP

- 1ST Sativa

@milehighdave420

Overall Grand Champion

- 1ST Overall Grand Champion
- 2ND Hybrid
- 2ND Sativa Dominant
- 2ND Indica Dominant

@leafdoctor1\_

PRO ★

**FIRST PLACE HYBRID**

MI MEDICAL CAREGIVER CUP 2023

LEAF DOCTOR  
MEDICAL CAREGIVER CUP

@LEAFDOCTOR1\_

Detroit Muscle  
(GMO x Eastside OG #4)

HIGH TIMES

- 1ST Hybrid
- 1ST Indica
- 1ST Sativa

@gringo\_farmer

FACE INDOOR

HAWAII ISLANDS CANNABIS CUP

- 1ST Indoor Indica

@norsepharms

PRO ★

**FIRST PLACE INDICA FLOWER**

FORE TWENTY SESH 2022

NORSE FARMS

Cap Junky Breeder Cut  
(Alien Cookies x Kush Mints)

- 1ST Indica Flower
- 2ND Hybrid Flower

**@greencloverfarm**

PRO

**FIRST PLACE  
GROW MASTER INDOOR**  
OREGON GROWERS CUP 2022



**@GREENCLOVERFARM**  
Jiffy Sherbet #2

**1ST** Grow Master Indoor

**@flowermountainfarmsak**

**SUPER BOOF**



**HIGH TIMES  
CANNABIS CUP ALASKA 2022  
WINNER**

**1ST** Best Hybrid

**@1904provisions**



**BEST OF  
NEW YORK**

**1ST** Celebrity Guest Pick

**@thesocietyc**

**HIGHTIMES  
CANNABIS CUP  
MICHIGAN  
INDICA FLOWER  
FIRST PLACE**



**@THESOCIETYC** **HIGH TIMES**

**1ST** Indica Flower

**@t.h.seeds\_official**



**DROP SEEDS  
NOT BOMBS  
3rd place  
Breeders Cup  
@ic420cup**

**3RD** Breeders Cup

**@greencloverfarm**



**OR LEAF  
DREYON  
2022  
LEAF  
BOWL  
WINNER  
INDOOR FLOWER  
BEST FUEL /**

**1ST** Indoor Flower

**@wow.town**



**1ST** Smokability Home Grown

**@zenleafca**



**4120 EDITION  
Farmers Cup  
2023  
LICENSED FLOWER  
BEST SMOKABILITY  
ZEN LEAF  
BLOCKBERRY  
People's Choice**

**2ND** Smokability Licensed Flower (People's Choice)

**@1904provisions**



**1ST** Smokability (People's Choice)  
**1ST** Appearance (People's Choice)  
**1ST** Highest combined cannabinoids

**BLENDED** 

Ideal for Craft and Home Growers using simple irrigation systems or hand watering. Complete and ready-to-use concentrates for the ultimate simplicity.

# SIMPLICITY

IN A BOTTLE



## KEY FEATURES

- Super-clean formula with no particulates or residue
- 7-step purification and filtration process
- Will not clog drippers/emitters
- Will not create biofilm
- Compatible with all fertigation systems and irrigation methods
- Works well in deep water culture (DWC) and hand watering
- Complete formula that needs no additional inputs
- Can be used with all water sources
- Minimal additives (CaMg, PK)

Scan code  
for Blended Line  
Feed Schedules



 **ATHENA**®



**Grow A & B** 2-PART VEGETATIVE NUTRIENT

CLONE	VEG	FLOWER
	☛	

- Complete 2-part base fertilizer with chelated microelements
- Encourages robust vegetative growth
- Contains additional nitrogen for lush foliage



**Bloom A & B** 2-PART FLOWERING NUTRIENT

CLONE	VEG	FLOWER
☛		☛

- Complete 2-part base fertilizer with chelated microelements
- Stimulates rapid onset of bud production
- Promotes higher quality yields



**CaMg** CALCIUM MAGNESIUM & IRON SUPPLEMENT

CLONE	VEG	FLOWER
	☛	☛

- Designed to supplement 2-part Athena® Grow A/B and Bloom A/B formulas.
- Provides optimal levels of calcium, magnesium, iron, and nitrogen while maintaining overall elemental balance during all growth stages.



**PK** BLOOM ENHANCER

CLONE	VEG	FLOWER
		☛

- Designed to supplement 2-part Athena® Bloom A/B formulas.
- Nitrogen-free booster provides additional phosphorus, potassium, magnesium, and sulfur that high-yielding plants require for maximal production and quality.

<b>BLOOM A</b>	(32 OZ)	(0.94 L)	<b>LQ-BLA-32OZ</b>
<b>BLOOM A</b>	(1 GAL)	(3.78 L)	<b>LQ-BLA-1G</b>
<b>BLOOM A</b>	(5 GAL)	(18.92 L)	<b>LQ-BLA-5G</b>
<b>BLOOM A</b>	(55 GAL)	(208.2 L)	<b>LQ-BLA-55G</b>
<b>BLOOM A</b>	(275 GAL)	(1041 L)	<b>LQ-BLA-275G</b>
<b>BLOOM B</b>	(32 OZ)	(0.94 L)	<b>LQ-BLB-32OZ</b>
<b>BLOOM B</b>	(1 GAL)	(3.78 L)	<b>LQ-BLB-1G</b>
<b>BLOOM B</b>	(5 GAL)	(18.92 L)	<b>LQ-BLB-5G</b>
<b>BLOOM B</b>	(55 GAL)	(208.2 L)	<b>LQ-BLB-55G</b>
<b>BLOOM B</b>	(275 GAL)	(1041 L)	<b>LQ-BLB-275G</b>

<b>GROW A</b>	(32 OZ)	(0.94 L)	<b>LQ-GWA-32OZ</b>
<b>GROW A</b>	(1 GAL)	(3.78 L)	<b>LQ-GWA-1G</b>
<b>GROW A</b>	(5 GAL)	(18.92 L)	<b>LQ-GWA-5G</b>
<b>GROW A</b>	(55 GAL)	(208.2 L)	<b>LQ-GWA-55G</b>
<b>GROW A</b>	(275 GAL)	(1041 L)	<b>LQ-GWA-275G</b>
<b>GROW B</b>	(32 OZ)	(0.94 L)	<b>LQ-GWB-32OZ</b>
<b>GROW B</b>	(1 GAL)	(3.78 L)	<b>LQ-GWB-1G</b>
<b>GROW B</b>	(5 GAL)	(18.92 L)	<b>LQ-GWB-5G</b>
<b>GROW B</b>	(55 GAL)	(208.2 L)	<b>LQ-GWB-55G</b>
<b>GROW B</b>	(275 GAL)	(1041 L)	<b>LQ-GWB-275G</b>

<b>CAMG</b>	(32 OZ)	(0.94 L)	<b>LQ-CM-32OZ</b>
<b>CAMG</b>	(1 GAL)	(3.78 L)	<b>LQ-CM-1G</b>
<b>CAMG</b>	(5 GAL)	(18.92 L)	<b>LQ-CM-5G</b>
<b>CAMG</b>	(55 GAL)	(208.2 L)	<b>LQ-CM-55G</b>
<b>CAMG</b>	(275 GAL)	(1041 L)	<b>LQ-CM-275G</b>
<b>PK</b>	(32 OZ)	(0.94 L)	<b>LQ-PK-32OZ</b>
<b>PK</b>	(1 GAL)	(3.78 L)	<b>LQ-PK-1G</b>
<b>PK</b>	(5 GAL)	(18.92 L)	<b>LQ-PK-5G</b>
<b>PK</b>	(55 GAL)	(208.2 L)	<b>LQ-PK-55G</b>
<b>PK</b>	(275 GAL)	(1041 L)	<b>LQ-PK-275G</b>

FEED PROGRAM							All measurements are mL per 10 L								
MIXING ORDER ↓	CLONE		VEG				FLOWER								
	Pre-Soak	Feed	W1	W2	W3	W4	W1	W2	W3	W4	W5	W6	W7	W8	W9
Balance	*Use as pH up		*Use as pH up				*Use as pH up *(Recommended for batch tank mixing and Dosatron. Do not use with NetaFlex) *If using Blended Balance, do not use an additional potassium silicate product.								
Crow B			29	29	29	29									
Crow A			29	29	29	29									
Bloom B	13	26					32	32	32	32	26	24	13	11	11
Bloom A	13	26					32	32	32	32	26	24	13	11	11
PK									11	16	24	26	32	26	26
CaMg			8-13	8-13	8-13	8-13	8-13	8-13	8-13	8-13	8-13	8-13	8-13		
Cleanse	3	3	5-13	5-13	5-13	5-13	5-13	5-13	5-13	5-13	5-13	5-13	5-13	5-13	5-13
EC	1.0	2.0	2.1	2.1	2.1	2.1	2.3	2.3	2.5	2.6	2.4	2.3	1.7	1.5	1.5
PPM 500	500	1000	1050	1050	1050	1050	1150	1150	1250	1300	1200	1150	850	750	750
PPM 700	700	1400	1470	1470	1470	1470	1610	1610	1750	1820	1680	1610	1190	1050	1050
pH	5.6		5.8-6.2 (Coco/Rockwool)		6.0-6.4 (Peat based mediums)		5.8-6.2 (Coco/Rockwool)			6.0-6.4 (Peat based mediums)			6.0-6.4 (All)		

SPRAY PROGRAM				All measurements are mL per L					
APPLICATION FREQUENCY			VEG				FLOWER		
			W1	W2	W3	W4	W1	W2	W3
IPM	Preventative	2x Week	24	24	24	24	24	24	24
	Pressure	3x Week	32	32	32	32	32	32	32
Stack	Maximize	2x Week	2	2	2	2	2	2	2

Can be mixed together with IPM

**PRE-SOAK**

**Coco**

- pH 5.5 - 5.8
- EC 3.5 - 4.0

**Rockwool**

- pH 5.0 - 5.5
- EC 2.5 - 3.0

**FLUSH**

RO + Cleanse	26 mL
EC	<0.1
PPM 500	<50
PPM 700	<70
pH	6.0 - 6.4

**Coco**  
Last 3 days

**Rockwool**  
Last day

**DISCLAIMER** - This is a baseline recommendation. Any adjustments made are at the growers discretion. Adjust the feed chart according to weeks needed to complete a run. Strain dependent.

Read the entire Directions for Use, Conditions of Warranties, and Limitations of Liability before using this product. If the terms are not acceptable, return the unopened product container at once. By using this product, user or buyer accepts the following Conditions, Disclaimer of Warranties, and Limitations of Liability. CONDITIONS: The directions for use of this product are believed to be adequate and must be followed carefully. However, it is impossible to eliminate all risks associated with the use of this product. Crop injury, ineffectiveness, or other unintended consequences may result because of such factors such as weather conditions, presence of other materials, or the manner of use or application, all of which are beyond the control of Athena Ag, Inc. All such risks shall be assumed by the user or buyer. DISCLAIMER OF WARRANTIES: To the extent consistent with applicable law, Athena Ag, Inc. makes no other warranties, express or implied, of merchantability or of fitness for a particular purpose or otherwise, that extend beyond the statements made on the product's label. No agent of Athena Ag, Inc. is authorized to make any warranties beyond those contained herein or to modify the warranties contained herein. To the extent consistent with applicable law, Athena Ag, Inc. disclaims any liability whatsoever for special, incidental, or consequential damages resulting from the use or handling of this product. LIMITATIONS OF LIABILITY: To the extent consistent with applicable law, the exclusive remedy of the user or buyer for any and all losses, injuries, or damages resulting from the use or handling of this product, whether in contract, warranty, tort, negligence, strict liability or otherwise, shall not exceed the purchase price paid, or at Athena Ag Inc.'s election, the replacement of product.







# LO-FLO PANEL CONFIGURATION

BLENDED

## AUTOMATE YOUR PROGRAM

Dosatrons provide precise and consistent delivery of fertilizers and additives, ensuring each plant receives the correct amount for optimal growth. This automation saves time and labor, reduces waste and cost, and minimizes the risk of human error.

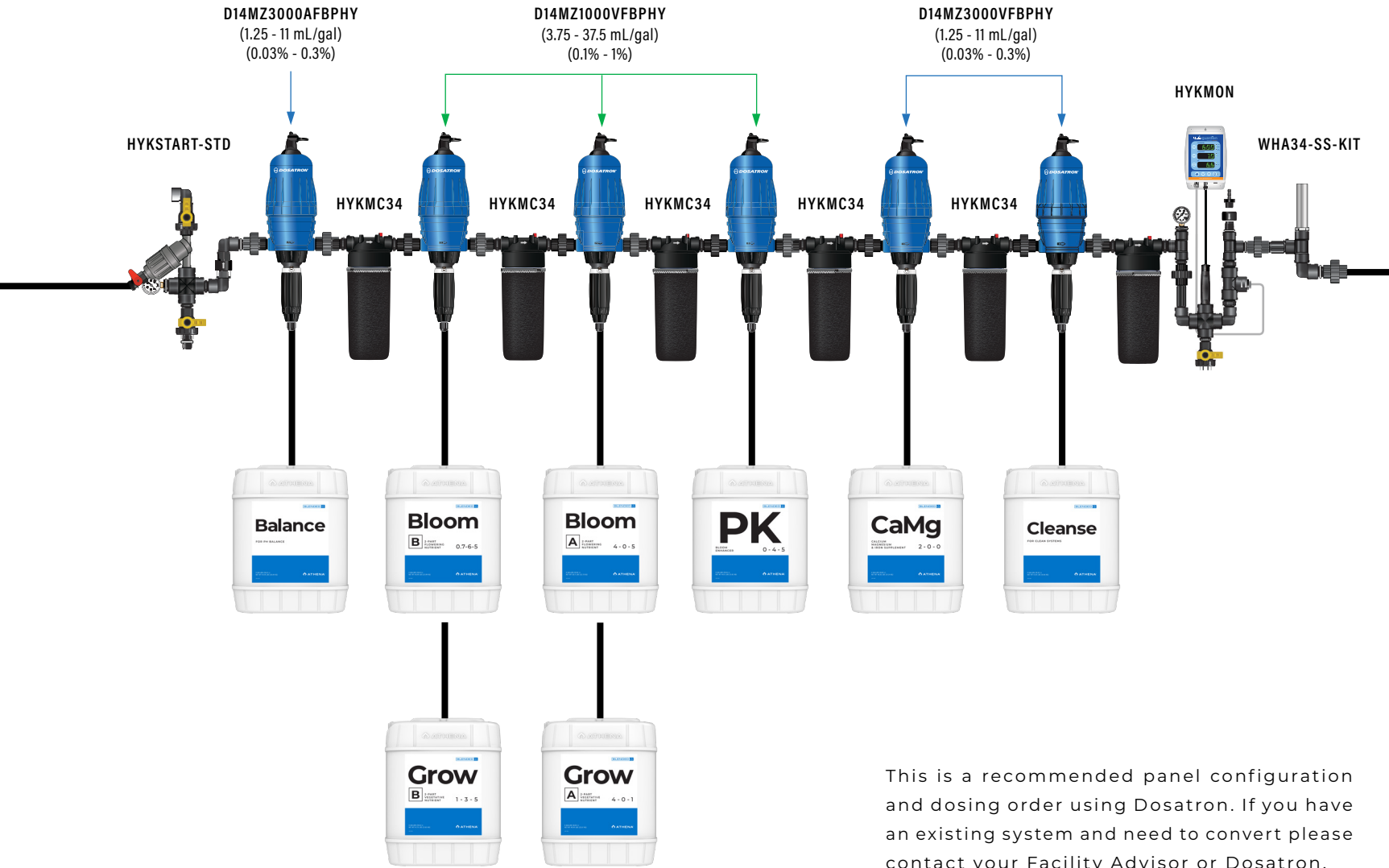

This is a recommended panel configuration and dosing order using Dosatron. If you have an existing system and need to convert please contact your Facility Advisor or Dosatron.

### CONTACT

ATHENA®  
FACILITY ADVISOR:

844-333-1818 #4

DOSATRON

1-800-523-8499



**WARNING:** IF THE PROPER MIXING ORDER IS NOT FOLLOWED, FORMATION OF PRECIPITATES MAY OCCUR AND IRRIGATION LINES MAY CLOG.

Read the entire Directions for Use, Conditions of Warranties, and Limitations of Liability before using this product. If the terms are not acceptable, return the unopened product container at once. By using this product, user or buyer accepts the following Conditions, Disclaimer of Warranties, and Limitations of Liability. CONDITIONS: The directions for use of this product are believed to be adequate and must be followed carefully. However, it is impossible to eliminate all risks associated with the use of this product. Crop injury, ineffectiveness, or other unintended consequences may result because of such factors such as weather conditions, presence of other materials, or the manner of use or application, all of which are beyond the control of Athena Ag, Inc. All such risks shall be assumed by the user or buyer. DISCLAIMER OF WARRANTIES: To the extent consistent with applicable law, Athena Ag, Inc. makes no other warranties, express or implied, of merchantability or of fitness for a particular purpose or otherwise, that extend beyond the statements made on the product's label. No agent of Athena Ag, Inc. is authorized to make any warranties beyond those contained herein or to modify the warranties contained herein. To the extent consistent with applicable law, Athena Ag, Inc. disclaims any liability whatsoever for special, incidental, or consequential damages resulting from the use or handling of this product. LIMITATIONS OF LIABILITY: To the extent consistent with applicable law, the exclusive remedy of the user or buyer for any and all losses, injuries, or damages resulting from the use or handling of this product, whether in contract, warranty, tort, negligence, strict liability or otherwise, shall not exceed the purchase price paid, or at Athena Ag Inc.'s election, the replacement of product.

Follow us on Instagram!

@Athena.Ag

A01.001

AthenaAg.com





Blended Line Feed/Runoff Targets													
	VEG				FLOWER								
	W1	W2	W3	W4	W1	W2	W3	W4	W5	W6	W7	*W8	**W9/Flush
EC	2.1	2.1	2.1	2.1	2.3	2.3	2.5	2.6	2.4	2.3	1.7	1.5	0.0 - 1.5
PH	5.8 - 6.2	5.8 - 6.2	5.8 - 6.2	5.8 - 6.2	5.9 - 6.3	5.9 - 6.3	5.9 - 6.3	5.9 - 6.3	5.9 - 6.3	5.9 - 6.3	5.9 - 6.3	5.9 - 6.3	5.9 - 6.3
RUNOFF TARGET EC	3.5 - 4.5	3.5 - 4.5	3.5 - 4.5	3.5 - 4.5	5.0 - 6.0	5.0 - 6.0	5.0 - 6.0	4.0 - 5.0	4.0 - 5.0	4.0 - 5.0	3.0 - 4.0	2.5 - 3.0	0.0 - 1.5
RUNOFF TARGET PH	5.8 - 6.2	5.8 - 6.2	5.8 - 6.2	5.8 - 6.2	5.9 - 6.3	5.9 - 6.3	5.9 - 6.3	5.9 - 6.3	5.9 - 6.3	5.9 - 6.3	5.9 - 6.3	5.9 - 6.3	5.9 - 6.3
DRYBACK TARGET	30% - 40% WC	30% - 40% WC	30% - 40% WC	30% - 40% WC	30% - 40% WC	50% - 60% WC	50% - 60% WC	30% - 40% WC	30% - 40% WC	30% - 40% WC	30% - 40% WC	50% - 60% WC	50% - 60% WC

## MONITORING DRYBACK

The key is having your substrate dryback overnight to the targeted percentage.

You can monitor drybacks by:

<b>1</b>		<b>2</b>	
	Picking up each pot before feeding to make a judgement call on how dry the substrate is.		Use a water content meter to monitor how much water is in the substrate.

Strive for one feed each morning with roughly 10-25% runoff when the lights come on. Aim for the substrate to dry back over a 24 hour period. This dryback period is very important to allow for optimal root development.

**WARNING: IF THE SUBSTRATE IS NOT DRYING BACK BY MORNING, YOU NEED TO LET IT DRYBACK BEFORE FEEDING TO AVOID OVERWATERING ISSUES.**

The goal is to have the whole garden feeding and drying back consistently every day.	You <b>DO NOT</b> want a situation where you're hand feeding multiple times per day.

## CHECKING RUNOFF

Monitor the runoff and make adjustments for the next feeding (if needed) based on runoff EC/pH and plant health. You want to be within +/- 1 EC of suggested runoff targets and within +/- 10% of dryback targets.

If you run more water through the substrate, there will be **lower EC in the substrate**.



3-3.5 Wk Veg – 6 plants per 1.2mx1.2m/1.5mx1.5m area

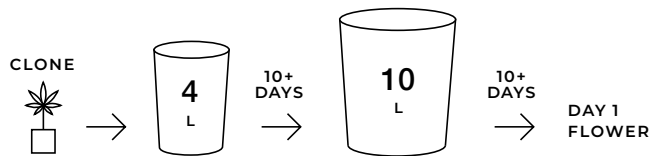

4-5 Wk Veg – 4 plants per 1.2mx1.2m/1.5mx1.5m area

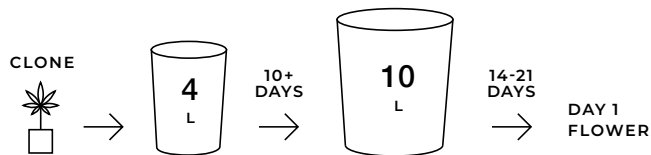

Read the entire Directions for Use, Conditions of Warranties, and Limitations of Liability before using this product. If the terms are not acceptable, return the unopened product container at once. By using this product, user or buyer accepts the following Conditions, Disclaimer of Warranties, and Limitations of Liability. CONDITIONS: The directions for use of this product are believed to be adequate and must be followed carefully. However, it is impossible to eliminate all risks associated with the use of this product. Crop injury, ineffectiveness, or other unintended consequences may result because of such factors such as weather conditions, presence of other materials, or the manner of use or application, all of which are beyond the control of Athena Ag, Inc. All such risks shall be assumed by the user or buyer. DISCLAIMER OF WARRANTIES: To the extent consistent with applicable law, Athena Ag, Inc. makes no other warranties, express or implied, of merchantability or of fitness for a particular purpose or otherwise, that extend beyond the statements made on the product's label. No agent of Athena Ag, Inc. is authorized to make any warranties beyond those contained herein or to modify the warranties contained herein. To the extent consistent with applicable law, Athena Ag, Inc. disclaims any liability whatsoever for special, incidental, or consequential damages resulting from the use or handling of this product. LIMITATIONS OF LIABILITY: To the extent consistent with applicable law, the exclusive remedy of the user or buyer for any and all losses, injuries, or damages resulting from the use or handling of this product, whether in contract, warranty, tort, negligence, strict liability or otherwise, shall not exceed the purchase price paid, or at Athena Ag Inc's election, the replacement of product.

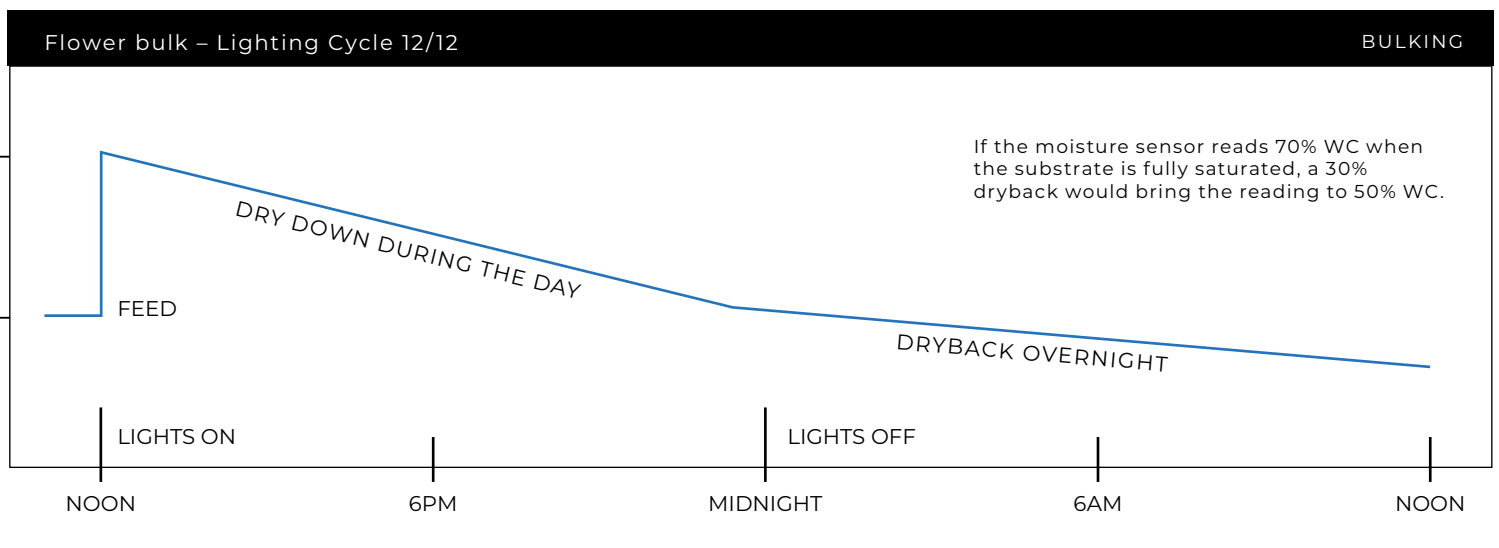
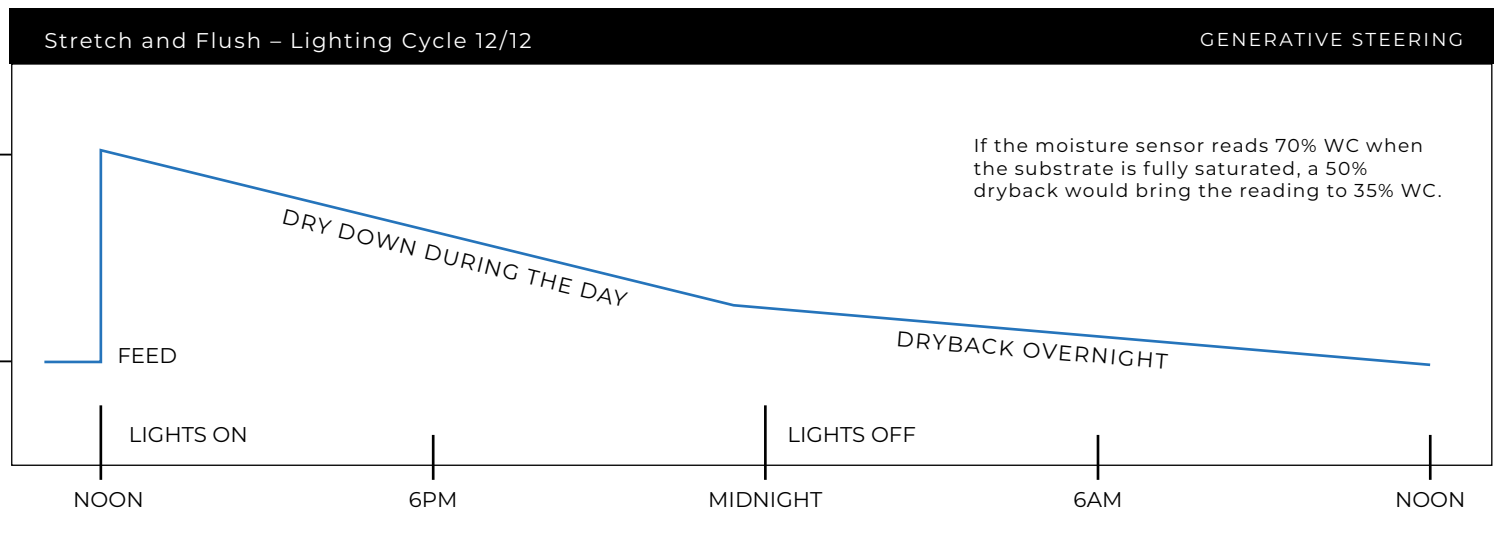
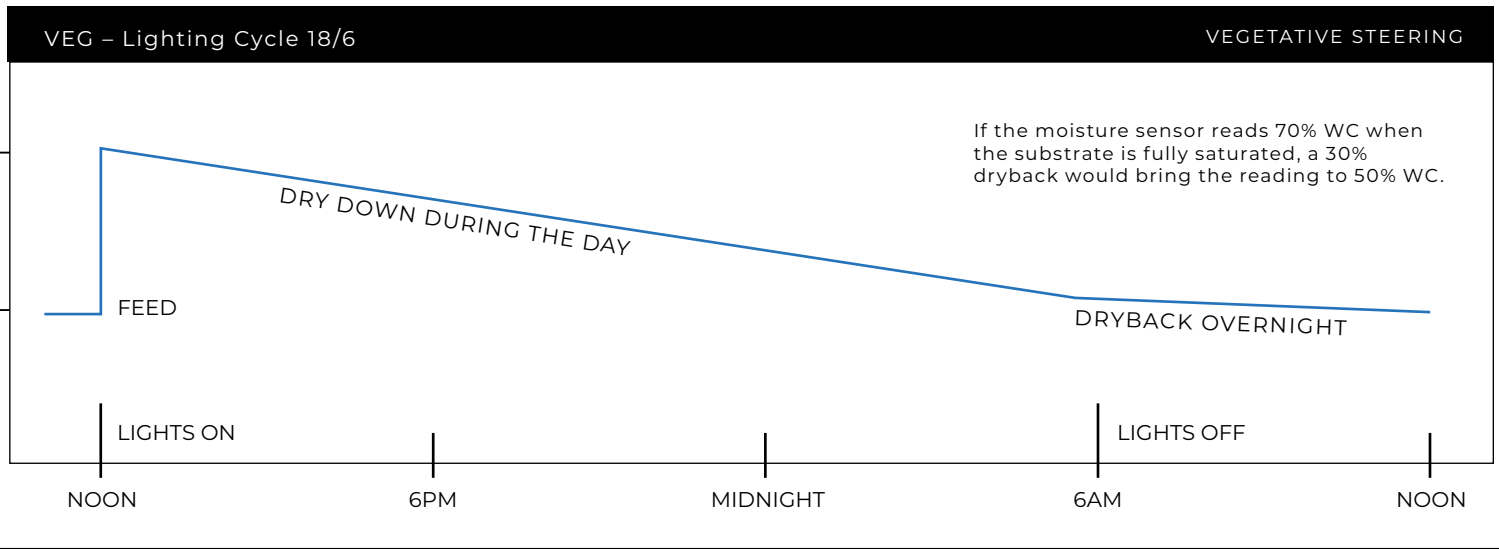

Read the entire Directions for Use, Conditions of Warranties, and Limitations of Liability before using this product. If the terms are not acceptable, return the unopened product container at once. By using this product, user or buyer accepts the following Conditions, Disclaimer of Warranties, and Limitations of Liability. CONDITIONS: The directions for use of this product are believed to be adequate and must be followed carefully. However, it is impossible to eliminate all risks associated with the use of this product. Crop injury, ineffectiveness, or other unintended consequences may result because of such factors as weather conditions, presence of other materials, or the manner of use or application, all of which are beyond the control of Athena Ag, Inc. All such risks shall be assumed by the user or buyer. DISCLAIMER OF WARRANTIES: To the extent consistent with applicable law, Athena Ag, Inc. makes no other warranties, express or implied, of merchantability or of fitness for a particular purpose or otherwise, that extend beyond the statements made on the product's label. No agent of Athena Ag, Inc. is authorized to make any warranties beyond those contained herein or to modify the warranties contained herein. To the extent consistent with applicable law, Athena Ag, Inc. disclaims any liability whatsoever for special, incidental, or consequential damages resulting from the use or handling of this product. LIMITATIONS OF LIABILITY: To the extent consistent with applicable law, the exclusive remedy of the user or buyer for any and all losses, injuries, or damages resulting from the use or handling of this product, whether in contract, warranty, tort, negligence, strict liability or otherwise, shall not exceed the purchase price paid, or at Athena Ag Inc's election, the replacement of product.

Follow us on Instagram!

@Athena.Ag

A01.002

AthenaAg.com





14-16 DAYS

**BLENDING**

# Clone Recipe

All measurements are mL per 10 L.



MIXING ORDER	CLONE	
	Pre-Soak	Feed
<b>Balance</b>	<b>Use as pH up</b> (Recommended for batch tank mixing and Dosatron. Do not use with NetaFlex)	
<b>Bloom B</b>	13	26
<b>Bloom A</b>	13	26
<b>Cleanse</b>	3	3
EC	1.0	2.0
PPM 500	500	1000
PPM 700	700	1400
pH	5.6	



**The Perfect Run.™**



**SCAN ME**

Scan code for access to our most current in-depth **Feed Schedules** and **Procedures.**





2-3 MONTHS

**BLENDABLE** (Mom Feed + Cup Solution)



# Mother & Veg Recipe

All measurements are mL per 10 L.

MIXING ORDER	VEG
Balance	Use as pH up (Recommended for batch tank mixing and Dosatron. Do not use with NetaFlex)
Grow B	29
Grow A	29
CaMg	8 - 13
Cleanse	5 - 13
EC	2.1
PPM 500	1050
PPM 700	1470
pH	5.8-6.2 (Coco/Rockwool) 6.0-6.4 (Peat-based mediums)



**The Perfect Run.™**

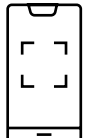

**SCAN ME**

Scan code for access to our most current in-depth **Feed Schedules** and **Procedures.**





BLEND 

# CANNABIS CUP WINS

@oklaboyz



OKLABOYZ FARMZ  
BOUTIQUE STYLE CANNABIS  
Slapz  
INDICA SATIVA FEM  
NET WEIGHT 3.5 GRAMS

OKLABOYZ FARMZ  
BOUTIQUE STYLE CANNABIS  
Apple Jax  
INDICA SATIVA FEM  
NET WEIGHT 3.5 GRAMS

OKLAHOMA  
CANNABIS AWARDS  
MUSIC FESTIVAL

1ST Best Indica

@tonyespo451



ATHENA

JACK HERER CUP  
2021

1ST Best Patient Flower

@growerscircle



HIGH TIMES

1ST Indica Flower

 ATHENA<sup>®</sup>

BLENDED LINE  
FLOWER



Photo: @mobilejay

PRO 

BLENDED 

Optimal fertilizer uptake starts with water quality. Athena® Cleanse and Balance keep water clean, buffered, and pH balanced.



**IMPROVED**  
WATER QUALITY

Scan code  
for Pro Line  
Feed Schedules



 **ATHENA**®





**Pro Balance**  
RAISES FERTILIZER SOLUTION PH

CLONE	VEG	FLOWER
🔥	🔥	🔥

- Made from fully soluble potassium carbonate
- First powdered pH up for cultivators
- Used to increase fertilizer solution pH
- May be mixed at any dilution for specific fertigation systems
- Helps buffer reverse osmosis (RO) water for more stable fertilizer solution
- Best used by adding first to irrigation water
- More cost-effective than competitors



**Balance**  
FOR PH BALANCE

CLONE	VEG	FLOWER
🔥	🔥	🔥

- Made from fully soluble potassium silicate
- Used to increase fertilizer solution pH
- Helps buffer reverse osmosis (RO) water for more stable fertilizer solution
- Best used by adding first to irrigation water
- Not recommended for advanced fertigation systems and pressure-compensated drippers
- Some silicate build-up may occur in irrigation systems over time
- More cost-effective than competitors



**Cleanse**  
FOR CLEAN SYSTEMS

CLONE	VEG	FLOWER
🔥	🔥	🔥

- Contains hypochlorous acid - a natural descaler
- Non-toxic, non-nutritive, low TDS, and pH neutral
- Useful as a growing media flush to clean and remove unwanted mineral build-up
- Increases Oxidation-Reduction Potential (ORP)
- Cleans inanimate scum, nutrients, organic particulates, and other contaminants
- Effective to remove mineral buildup (scale) in growing media and irrigation lines
- Keeps irrigation system cleaner and running efficiently longer
- Prevents drippers and emitters from clogging
- Smells like bleach but IS NOT bleach
- Made from sodium chloride (salt) through a proprietary electrolysis process
- Long-shelf life - stable and concentrated at least 12 months

**⚠️ WARNING:** THIS PRODUCT IS CORROSIVE TO MOST METALS. DO NOT EXPOSE POWDER OR LIQUID TO ALUMINUM. KEEP AWAY FROM LOW PH PRODUCTS AND STORE IN A WELL-VENTILATED AREA. ALWAYS WEAR PROPER PPE WHEN HANDLING, INCLUDING RESPIRATOR, EYE PROTECTION AND SKIN COVERINGS.

<b>PRO BALANCE</b>	(10 LB BOX)	(4.5 KG)	<b>PRO-UP-10</b>
<b>PRO BALANCE</b>	(25 LB BOX)	(11.3 KG)	<b>PRO-UP-25</b>
<b>BALANCE</b>	(32 OZ)	(0.94 L)	<b>LQ-SIL-320Z</b>
<b>BALANCE</b>	(1 GAL)	(3.78 L)	<b>LQ-SIL-1G</b>



<b>BALANCE</b>	(5 GAL)	(18.92 L)	<b>LQ-SIL-5G</b>
<b>BALANCE</b>	(55 GAL)	(208.2 L)	<b>LQ-SIL-55G</b>
<b>BALANCE</b>	(275 GAL)	(1041 L)	<b>LQ-SIL-275G</b>
<b>CLEANSE</b>	(32 OZ)	(0.94 L)	<b>LQ-CL-320Z</b>

<b>CLEANSE</b>	(1 GAL)	(3.78 L)	<b>LQ-CL-1G</b>
<b>CLEANSE</b>	(5 GAL)	(18.92 L)	<b>LQ-CL-5G</b>
<b>CLEANSE</b>	(55 GAL)	(208.2 L)	<b>LQ-CL-55G</b>
<b>CLEANSE</b>	(275 GAL)	(1041 L)	<b>LQ-CL-275G</b>







## Athena® Balance

Determine how much **Athena® Balance** is needed based on the feed recipe and source water. Everybody's source water and recipe is different. If you have alkaline source water, you will require less Balance. If you have more acidic source water, you will require more Balance. Follow this procedure to determine how much you will need.

Balance Usage Recommendation	
	<p><b>Athena® Balance</b></p> <p>Ideal for most applications due to the secondary plant benefit of silicates. (Like hand mixing and Dosatron. Do not use in venturi based systems.)</p>
	<p><b>Athena® Pro Balance</b></p> <p>Designed for use in venturi-based systems to eliminate potential clogging. (like Netaflex)</p>
<p>If you are using Pro Balance, you will need to make a <b>Stock Concentrate</b> first. Scan this QR to make a <b>Stock Concentrate</b>.</p> 	

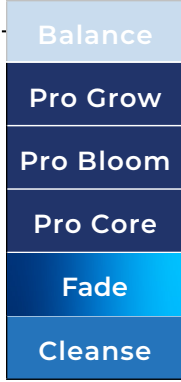
Dosatron Procedure	
<b>1 Set</b>	Set the Dosatron unit dilution rate for <b>Balance</b> to the middle of the range. (This is more accurate)
<b>2 On</b>	Turn on <b>Balance</b> doser and fertilizer part dosers and run to waste.
<b>3 Adjust</b>	Monitor pH until it stabilizes. Adjust <b>Balance</b> application rate on your doser to achieve your target pH.

 **NOTE: BALANCE APPLICATION RATE VARIES WEEK TO WEEK IF YOU ARE USING THE BLENDED LINE.**

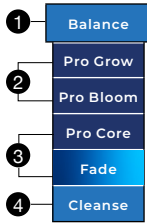
Hand Mixing Procedure		
		<p><b>Mixing Order</b></p> <p>It is very important that when mixing a batch reservoir, Balance is always first in the mixing order. For the sake of this test, Balance is moved to the end of the mixing order. You may notice some precipitation or cloudiness when mixing Balance after fertilizer. This doesn't impact the plant, but this is why Balance is first in the mixing order. The same thing is true for <b>Blended Line</b> and <b>Pro Line</b>.</p> <ul style="list-style-type: none"> <li>• <b>Balance last in mix order just to establish the application rate.</b></li> </ul>
<b>1 Mix</b>	Mix your batch tank to desired EC level with fertilizer.	
<b>2 Measure</b>	Measure how much <b>Balance</b> it takes to get to your desired pH level. (1 mL/4 L increments)	
<b>3 Record</b>	Write down how much <b>Balance</b> it took to get to desired pH level.	
<p>On your next batch, <b>add Balance first,</b> (the amount that you wrote down) then mix fertilizer. (You should be at your desired pH level.)</p>		

Read the entire Directions for Use, Conditions of Warranties, and Limitations of Liability before using this product. If the terms are not acceptable, return the unopened product container at once. By using this product, user or buyer accepts the following Conditions, Disclaimer of Warranties, and Limitations of Liability. CONDITIONS: The directions for use of this product are believed to be adequate and must be followed carefully. However, it is impossible to eliminate all risks associated with the use of this product. Crop injury, ineffectiveness, or other unintended consequences may result because of such factors such as weather conditions, presence of other materials, or the manner of use or application, all of which are beyond the control of Athena Ag, Inc. All such risks shall be assumed by the user or buyer. DISCLAIMER OF WARRANTIES: To the extent consistent with applicable law, Athena Ag, Inc. makes no other warranties, express or implied, of merchantability or of fitness for a particular purpose or otherwise, that extend beyond the statements made on the product's label. No agent of Athena Ag, Inc. is authorized to make any warranties beyond those contained herein or to modify the warranties contained herein. To the extent consistent with applicable law, Athena Ag, Inc. disclaims any liability whatsoever for special, incidental, or consequential damages resulting from the use or handling of this product. LIMITATIONS OF LIABILITY: To the extent consistent with applicable law, the exclusive remedy of the user or buyer for any and all losses, injuries, or damages resulting from the use or handling of this product, whether in contract, warranty, tort, negligence, strict liability or otherwise, shall not exceed the purchase price paid, or at Athena Ag Inc.'s election, the replacement of product.

STEP 1

STOCK CONCENTRATE PROCEDURE

**CAUTION: A CONCENTRATE SHOULD NEVER BE FED DIRECTLY TO YOUR PLANTS. THE CONCENTRATE MIX IS MEANT FOR MAKING A BATCH RESERVOIR.**

**28** CONCENTRATE MIX RATE  
**grams/Liter**

If using a different concentrate mix rate, see **Dosage Reference Guide**.



**1A** Fill container with water to about **80% of final volume.**

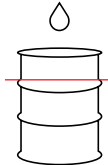

**1B** Empty entire contents of **Pro Line Pouch**. (always use a full pouch)

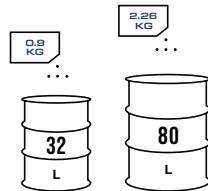

**1C** Mix thoroughly until all granules are dissolved. (approx 15-30 minutes)



**1D** Top off container to **final volume**. Mix one final time for 1-2 minutes to ensure stock tank uniformity.

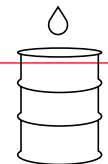

Athena® Pro Balance

You now have a concentrated pH up solution, proceed to making a **Batch Reservoir**.



STEP 2

BATCH RESERVOIR PROCEDURES

Netaflex

<b>2A</b> Configure	Configure the rotameter for <b>Pro Balance</b> to the middle range allowing for more adjustment flexibility.
<b>2B</b> Set	Set your Netaflex to the target pH parameters.
<b>2C</b> Test	Run full irrigation program to verify pH adjustment is accurate. A higher <b>Pro Balance</b> concentrate may exceed dosage limits of the Netaflex (28 g/L recommended). <i>Dilute the solution if needed.</i>

Balance Usage Recommendation



Athena® Balance

Ideal for most applications due to the secondary plant benefit of silicates. (Like hand mixing and Dosatron. Do not use in venturi based systems.)



Athena® Pro Balance

Designed for use in venturi-based systems to eliminate potential clogging. (Like Netaflex)

If you are using Dosatron or hand mixing reference the **Balance Application Rate**.



Read the entire Directions for Use, Conditions of Warranties, and Limitations of Liability before using this product. If the terms are not acceptable, return the unopened product container at once. By using this product, user or buyer accepts the following Conditions, Disclaimer of Warranties, and Limitations of Liability. CONDITIONS: The directions for use of this product are believed to be adequate and must be followed carefully. However, it is impossible to eliminate all risks associated with the use of this product. Crop injury, ineffectiveness, or other unintended consequences may result because of such factors such as weather conditions, presence of other materials, or the manner of use or application, all of which are beyond the control of Athena Ag, Inc. All such risks shall be assumed by the user or buyer. DISCLAIMER OF WARRANTIES: To the extent consistent with applicable law, Athena Ag, Inc. makes no other warranties, express or implied, of merchantability or of fitness for a particular purpose or otherwise, that extend beyond the statements made on the product's label. No agent of Athena Ag, Inc. is authorized to make any warranties beyond those contained herein or to modify the warranties contained herein. To the extent consistent with applicable law, Athena Ag, Inc. disclaims any liability whatsoever for special, incidental, or consequential damages resulting from the use or handling of this product. LIMITATIONS OF LIABILITY: To the extent consistent with applicable law, the exclusive remedy of the user or buyer for any and all losses, injuries, or damages resulting from the use or handling of this product, whether in contract, warranty, tort, negligence, strict liability or otherwise, shall not exceed the purchase price paid, or at Athena Ag Inc.'s election, the replacement of product.

Follow us on Instagram!

@Athena.Ag

A02.004

AthenaAg.com

ATHENA®

IPW 

FOLIAR 

PROTECT YOUR  
**HUSTLE**  
LEVEL UP YOUR  
**CANOPY**

Easy-to-use leaf wash used to beautify foliage and provide nutrition in a single spray application. Safe for spraying on plants without compromising flavor or quality.

Scan code  
for IPW Line  
Procedures



 **ATHENA**<sup>®</sup>



### **IPW**

### IPW INTEGRATED PLANT WASH

CLONE	VEG	FLOWER
🔥	🔥	🔥

- No harmful chemicals - citric acid and horticultural oils
- Use IPW as a leaf wash to beautify foliage
- Easy spray application
- Can be used in all growth stages
- Compatible with Stack - can mix in the same sprayer for simultaneous application

### **FOLIAR**

### Stack BLOOM ENHANCER

CLONE	VEG	FLOWER
🔥	🔥	🔥

- Encourages healthy growth, transition, and flowering
- Amino acids for optimal plant health performance
- Contains natural kelp-derived hormones to encourage lateral growth
- Contains humic acid derived from kelp
- Fully compatible with Athena<sup>®</sup> IPW - can mix in the same sprayer for simultaneous application
- No pH adjustment necessary

IPW	(32 OZ)	(0.94 L)	EU-IPW-32OZ
IPW	(1 GAL)	(3.78 L)	EU-IPW-1G
IPW	(5 GAL)	(18.92 L)	EU-IPW-5G

STACK	(32 OZ)	(0.94 L)	LQ-STK-32OZ
STACK	(1 GAL)	(3.78 L)	LQ-STK-1G
STACK	(5 GAL)	(18.92 L)	LQ-STK-5G
STACK	(55 GAL)	(208.2 L)	LQ-STK-55G

*All measurements are mL per liter		VEG				FLOWER		
Application Frequency		W1	W2	W3	W4	W1	W2	W3
Preventative TANK MIX (Spray 2x per week)	IPW	24	24	24	24	24	24	24
	Stack	2	2	2	2	2	2	2

## Tank Mix Advantages

Protect your hustle by using **Athena® IPW** as a leaf wash to beautify foliage. Leaf washing plants offers a range of compelling benefits that contribute to their overall health and vitality. By removing accumulated dust, pollutants, and potential contaminants from the leaves' surfaces, the plants' capacity for efficient photosynthesis increases, which is essential for optimal growth and robust yields. Cleaner leaves can also lead to better absorption of nutrients and foliar sprays, enabling the plants to access vital elements necessary for their development. Ultimately, leaf washing is a proactive and preventive measure that fosters vigorous growth and supports the cultivation of high-quality, potent flowers.

**Athena® Stack**, being derived from kelp extract (*Ascophyllum nodosum*), provides bioavailable nutrients which create favorable conditions for lateral growth, bud development, and improved vigor during transition.

Mixing both **Athena® IPW** and **Athena® Stack** together in the same solution is compatible for a foliar application and will result in less wasted product as well as save on labor costs.



**IPW**  
Integrated Plant Wash



**Stack**  
Bloom Enhancer

## Spray Procedure

**CAUTION: TO PREVENT RESIDUE FROM FORMING ON THE FOLIAGE, WE SUGGEST USING RO WATER.**

1 <b>Fill</b>	Fill a container with RO water for the amount of plants you are going to spray.
2 <b>IPW</b>	Add <b>Athena® IPW</b> at 24 mL/L and agitate until thoroughly mixed.
3 <b>Stack</b>	Add 2 mL/L of <b>Athena® Stack</b> and agitate until it is mixed. Contains organic ingredient that could separate in storage so shake well before each use.
4 <b>Saturate</b>	Fully saturate the substrate with the current fertilizer water. If the plant is fully hydrated, it will not absorb <b>IPW</b> through its leaves. If the plant is dehydrated, it will absorb <b>IPW</b> through its leaves. Skipping this step can cause burning or phytotoxic reactions.
5 <b>Temp</b>	Lower temperature to around 22° C and use dehumidifiers to maintain humidity around 55-65% to prevent mold and mildew issues.
6 <b>Lights</b>	Only spray when high intensity lights are turned off to prevent burning (Work lights or green lights only, no grow lights).
7 <b>Spray</b>	Start by spraying the substrate, following up the stalk making sure to drench the undersides of the leaves.
8 <b>Spray</b>	Follow with a spray over the top to ensure full saturation of all plant foliage.
9 <b>Dry</b>	Allow enough time to dry (3-4 hours) before high intensity lights are turned on.

Read the entire Directions for Use, Conditions of Warranties, and Limitations of Liability before using this product. If the terms are not acceptable, return the unopened product container at once. By using this product, user or buyer accepts the following Conditions, Disclaimer of Warranties, and Limitations of Liability. **CONDITIONS:** The directions for use of this product are believed to be adequate and must be followed carefully. However, it is impossible to eliminate all risks associated with the use of this product. Crop injury, ineffectiveness, or other unintended consequences may result because of such factors such as weather conditions, presence of other materials, or the manner of use or application, all of which are beyond the control of Athena Ag, Inc. All such risks shall be assumed by the user or buyer. **DISCLAIMER OF WARRANTIES:** To the extent consistent with applicable law, Athena Ag, Inc. makes no other warranties, express or implied, of merchantability or of fitness for a particular purpose or otherwise, that extend beyond the statements made on the product's label. No agent of Athena Ag, Inc. is authorized to make any warranties beyond those contained herein or to modify the warranties contained herein. To the extent consistent with applicable law, Athena Ag, Inc. disclaims any liability whatsoever for special, incidental, or consequential damages resulting from the use or handling of this product. **LIMITATIONS OF LIABILITY:** To the extent consistent with applicable law, the exclusive remedy of the user or buyer for any and all losses, injuries, or damages resulting from the use or handling of this product, whether in contract, warranty, tort, negligence, strict liability or otherwise, shall not exceed the purchase price paid, or at Athena Ag Inc.'s election, the replacement of product.

Follow us on Instagram!

*All measurements are mL per liter		VEG				FLOWER				
Application Frequency		W1	W2	W3	W4	W1	W2	W3		
<b>Routine</b> (General cleaning and prevention of dust on leaves)	Spray 2x per week	24	24	24	24	24	24	24		
<b>Remedial</b> (Moderately dusty environments or moderately soiled leaves)	Spray 3x per week	32	32	32	32	32	32	32		
<b>Restorative</b> (Extremely dusty environments or highly soiled leaves)	• Spray 2 day • Off 1 day Repeat above for a 9 day total cycle.	M	T	W	TH	F	S	SU	M	T
		32	32	X	32	32	X	32	32	X

### Maintaining Healthy Plants

Protect your hustle by using **Athena® IPW** as a leaf wash to beautify foliage. Leaf washing plants offers a range of compelling benefits that contribute to their overall health and vitality. By removing accumulated dust, pollutants, and potential contaminants from the leaves' surfaces, the plants' capacity for efficient photosynthesis increases, which is essential for optimal growth and robust yields. Cleaner leaves can also lead to better absorption of nutrients and foliar sprays, enabling the plants to access vital elements necessary for their development. Ultimately, leaf washing is a proactive and preventive measure that fosters vigorous growth and supports the cultivation of high-quality, potent flowers.



Wash & Beautify Foliage

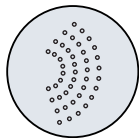

Easy Spray Application



Use in all Growth Stages



**IPW**  
Integrated Plant Wash

### Spray Procedure

**CAUTION: TO PREVENT RESIDUE FROM FORMING ON THE FOLIAGE, WE SUGGEST USING RO WATER.**

- |                   |   |
|-------------------|---|
| <b>1 Fill</b>     | Fill a container with RO water for the amount of plants you are going to spray.   |
| <b>2 IPW</b>      | Add <b>Athena® IPW</b> at 24 mL/L and agitate until thoroughly mixed.   |
| <b>3 Saturate</b> | Fully saturate the substrate with the current fertilizer water. If the plant is fully hydrated, it will not absorb <b>IPW</b> through its leaves. If the plant is dehydrated, it will absorb <b>IPW</b> through its leaves. Skipping this step can cause burning or phytotoxic reactions. |
| <b>4 Temp</b>     | Lower temperature to around 22° C and use dehumidifiers to maintain humidity around 55-65% to prevent mold and mildew issues.   |
| <b>5 Lights</b>   | Only spray when high intensity lights are turned off to prevent burning (Work lights or green lights only, no grow lights).   |
| <b>6 Spray</b>    | Start by spraying the substrate, following up the stalk making sure to fully drench all leaf and stem surfaces.   |
| <b>7 Spray</b>    | Follow with a spray over the top to ensure full saturation of all plant foliage.  |
| <b>8 Dry</b>      | Allow enough time to dry (3-4 hours) before high intensity lights are turned on.  |

Read the entire Directions for Use, Conditions of Warranties, and Limitations of Liability before using this product. If the terms are not acceptable, return the unopened product container at once. By using this product, user or buyer accepts the following Conditions, Disclaimer of Warranties, and Limitations of Liability. CONDITIONS: The directions for use of this product are believed to be adequate and must be followed carefully. However, it is impossible to eliminate all risks associated with the use of this product. Crop injury, ineffectiveness, or other unintended consequences may result because of such factors such as weather conditions, presence of other materials, or the manner of use or application, all of which are beyond the control of Athena Ag, Inc. All such risks shall be assumed by the user or buyer. DISCLAIMER OF WARRANTIES: To the extent consistent with applicable law, Athena Ag, Inc. makes no other warranties, express or implied, of merchantability or of fitness for a particular purpose or otherwise, that extend beyond the statements made on the product's label. No agent of Athena Ag, Inc. is authorized to make any warranties beyond those contained herein or to modify the warranties contained herein. To the extent consistent with applicable law, Athena Ag, Inc. disclaims any liability whatsoever for special, incidental, or consequential damages resulting from the use or handling of this product. LIMITATIONS OF LIABILITY: To the extent consistent with applicable law, the exclusive remedy of the user or buyer for any and all losses, injuries, or damages resulting from the use or handling of this product, whether in contract, warranty, tort, negligence, strict liability or otherwise, shall not exceed the purchase price paid, or at Athena Ag Inc.'s election, the replacement of product.

Follow us on Instagram!

@Athena.Ag

A02.001

AthenaAg.com





PROTECT YOUR

**HUSTLE**

**ATHENA®**





# DISCLAIMER

Read the entire Directions for Use, Conditions of Warranties, and Limitations of Liability before using this product. If the terms are not acceptable return the unopened product container at once. By using this product, user or buyer accepts the following Conditions, Disclaimer of Warranties, and Limitations of Liability.

**CONDITIONS:** The directions for use of this product are believed to be adequate and must be followed carefully. However, it is impossible to eliminate all risks associated with the use of this product. Crop injury, ineffectiveness, or other unintended consequences may result because of such factors such as weather conditions, presence of other materials, or the manner of use or application, all of which are beyond the control of Athena Ag, Inc. All such risks shall be assumed by the user or buyer.

**DISCLAIMER OF WARRANTIES:** To the extent consistent with applicable law, Athena Ag, Inc. makes no other warranties, express or implied, of merchantability or of fitness for a particular purpose or otherwise, that extend beyond the statements made on the product's label. No agent of Athena Ag, Inc. is authorized to make any warranties beyond those contained herein or to modify the warranties contained herein. To the extent consistent with applicable law, Athena Ag, Inc. disclaims any liability whatsoever for special, incidental, or consequential damages resulting from the use or handling of this product.

**LIMITATIONS OF LIABILITY:** To the extent consistent with applicable law, the exclusive remedy of the user or buyer for any and all losses, injuries, or damages resulting from the use or handling of this product, whether in contract, warranty, tort, negligence, strict liability or otherwise, shall not exceed the purchase price paid, or at Athena Ag Inc.'s election, the replacement of product.

CLEAN ✦

A cultivator's front-line defense against pathogens. The three-part system cleans, disinfects, and sanitizes irrigation systems and hard surfaces in any size cultivation.

# START CLEAN EVERY TIME



## KEY FEATURES

- Clean and sanitize rooms between flowering cycles
- Eliminates biofilm, bacteria, molds, and mildews
- Maintain an optimal irrigation system
- Effective low mix rate for cost
- Does not affect taste, odor, or color

Scan code  
for Clean Line  
Procedures



 ATHENA®



**Reset**  
HARD SURFACE SANITIZER & DISINFECTANT

**⚠ WARNING:** RECOMMENDED ONLY FOR NON-PLANT CLEANING OPERATIONS. USING CLEAN LINE ON OR AROUND PLANTS MAY IMPACT PLANT HEALTH.

- Anti-microbial formulation that cleans, sanitizes and disinfects
- Disperses/penetrates biofilms
- Kills bacteria, mold, fungus, and yeast
- Contains EPA-registered peroxyacetic acid (PAA)
- Fast-acting formula
- Non-foaming (unless used with Athena® Perafoam)
- No rinse required
- Breaks down into carbon dioxide and water – no disinfection byproducts
- Non-corrosive to stainless steel and aluminum
- Safe for sprayers and foggers
- Sanitizes: walls, benches, floors, equipment, shelves, carts, tools



**Perafoam**  
FOAM ADJUVANT

**⚠ WARNING:** RECOMMENDED ONLY FOR NON-PLANT CLEANING OPERATIONS. USING CLEAN LINE ON OR AROUND PLANTS MAY IMPACT PLANT HEALTH.

- Highly concentrated foaming agent
- Superior sanitation and greater efficacy when used with Athena Reset
- Safe for use with an active oxidizer
- Proprietary surfactant technology for increased coverage time
- Low temperature tolerant (As low as 35°)
- Hard-water tolerant
- One-year shelf life once opened
- Designed for use with Athena® Reset
- Always use with Athena® Reset Foamer



**Renew**  
WATER LINE CLEANER & DESCALER

**⚠ WARNING:** RECOMMENDED ONLY FOR NON-PLANT CLEANING OPERATIONS. USING CLEAN LINE ON OR AROUND PLANTS MAY IMPACT PLANT HEALTH.

- Specialized blend of acids, oxidizers, and chelators
- Removes and flushes heavy biofilm and mineral build-up
- Multiple modes of action is more powerful than strictly acid-based cleaners
- Keep irrigation systems running optimally
- Cleans pumps, filters, emitters, manifolds, valves, and membranes
- Restores and extends the life of poorly functioning irrigation systems
- Low mix rate for cost efficiency
- Safe for use in irrigation pipes as well as drip lines in between crop cycles
- Contains etidronic acid (HEDP) and hydrogen peroxide (H<sub>2</sub>O<sub>2</sub>)



**Reset Foamer**  
2-Part Concentrate Foamer

**⚠ WARNING:** RECOMMENDED ONLY FOR NON-PLANT CLEANING OPERATIONS. USING CLEAN LINE ON OR AROUND PLANTS MAY IMPACT PLANT HEALTH.

- Purpose-built system for cleaning, sanitizing, and disinfecting hard surfaces
- Foaming system is pre-calibrated to the exact usage rates of Athena® Reset and Athena® Perafoam
- Draws from two concentrated product tanks simultaneously
- Minimizes hazardous chemical handling
- Dilution rate is preset to 1 oz per gallon
- Powered by compressed air (compressor not included)
- Quick-change pump with in-line strainer to protect from debris
- Onboard water tank – 15 gallon (56.8 liter) capacity
- 50 ft kink-free hose with stainless steel fan pattern spray nozzle

RESET	1 GAL	(3.78 L)	CL-RES-1G
RESET	5 GAL	(18.92 L)	CL-RES-5G
RESET	55 GAL	(208.2 L)	CL-RES-55G
RESETFOAMER	50 FOOT	(15.2 M)	CL-FOAM2-50

RENEW	1 GAL	(3.78 L)	CL-REN-1G
RENEW	5 GAL	(18.92 L)	CL-REN-5G
RENEW	55 GAL	(208.2 L)	CL-REN-55G

PERAFOAM	1 GAL	(3.78 L)	CL-PER-1G
PERAFOAM	5 GAL	(18.92 L)	CL-PER-5G
PERAFOAM	55 GAL	(208.2 L)	CL-PER-55G

\*Not all SKUs are available in all markets. Contact your Dealer/Distributor for product availability based on region.

## Reset Your Room

Cleaning is one of the most important steps you take to eliminate pathogens in your garden. **Athena® Reset** and **Athena® Perafoam** were developed to give you a clean start going into every run. Use the **Athena® Clean Line** in between cycles to clean, disinfect, and sanitize tables, floors, trellis, irrigation lines; any hard surface you or your plants touch. Follow the procedures below in between crop cycles to ensure you start clean every time!

After harvesting a room, ensure all debris is cleared out of the room. The room can then be heat treated, bringing the internal temperature to 60°C, if possible.

### RESET (non-foaming spray application)

1 Add	Add <b>Athena® Reset</b> into a sprayer at a rate of 8 mL per L of water.
2 Spray	Spray all hard surfaces to sanitize and disinfect.
3 Hold	Let dry. No rinse is required.

### Other Foamer Systems

1 Add	Add <b>Athena® Perafoam</b> at a rate of 8 mL per L of water.  <b>NOTE:</b> Different systems may require higher rates to achieve desired foam consistency.
2 Add	Add <b>Athena® Reset</b> at a rate of 8 mL per L of water.
3 Mix	Mix the solution thoroughly.
4 Adjust	Use manufacturer's recommendations to adjust foamer settings for the desired foam characteristics.



Athena®  
Reset



Athena®  
Perafoam



Athena®  
Reset Foamer

## Reset Foamer Procedure:

**WARNING: MAKE SURE TO WEAR PROPER PPE WHEN HANDLING THESE PRODUCTS, INCLUDING GOGGLES, FACE SHIELD WITH RESPIRATOR, COVERALLS WORN OVER LONG-SLEEVED SHIRT AND LONG PANTS, SOCKS, CHEMICAL RESISTANT FOOTWEAR, AND WATERPROOF GLOVES.**

1 Fill	Fill the "Perafoam" tank with <b>Athena® Perafoam</b> .
2 Fill	Fill the "Reset" tank with <b>Athena® Reset</b> .
3 Fill	Fill the 15 gallon (57 liter) water tank.
4 Confirm	Confirm that the discharge ball valve is closed.
5 Connect	Connect an appropriate air compressor. (5-10 CFM at 50 psi)
6 Secure	Ensure all connections are secure.
7 Open	Point the spray nozzle at a surface and open the discharge ball valve.
8 Coat	Evenly coat the surface with foam and leave for 30-60 minutes.
9 Scrub	Scrub surface if desired.
10 Rinse	Rinse with clean water if desired (not required).
11 Disconnect	Disconnect the air supply from the unit.
12 Open	Open discharge ball valve to relieve pressure still in the system.
13 Store	Store unit with discharge ball valve in the closed position.

Read the entire Directions for Use, Conditions of Warranties, and Limitations of Liability before using this product. If the terms are not acceptable, return the unopened product container at once. By using this product, user or buyer accepts the following Conditions, Disclaimer of Warranties, and Limitations of Liability. **CONDITIONS:** The directions for use of this product are believed to be adequate and must be followed carefully. However, it is impossible to eliminate all risks associated with the use of this product. Crop injury, ineffectiveness, or other unintended consequences may result because of such factors such as weather conditions, presence of other materials, or the manner of use or application, all of which are beyond the control of Athena Ag, Inc. All such risks shall be assumed by the user or buyer. **DISCLAIMER OF WARRANTIES:** To the extent consistent with applicable law, Athena Ag, Inc. makes no other warranties, express or implied, of merchantability or of fitness for a particular purpose or otherwise, that extend beyond the statements made on the product's label. No agent of Athena Ag, Inc. is authorized to make any warranties beyond those contained herein or to modify the warranties contained herein. To the extent consistent with applicable law, Athena Ag, Inc. disclaims any liability whatsoever for special, incidental, or consequential damages resulting from the use or handling of this product. **LIMITATIONS OF LIABILITY:** To the extent consistent with applicable law, the exclusive remedy of the user or buyer for any and all losses, injuries, or damages resulting from the use or handling of this product, whether in contract, warranty, tort, negligence, strict liability or otherwise, shall not exceed the purchase price paid, or at Athena Ag Inc.'s election, the replacement of product.

Follow us on Instagram!

## Renew Your Lines

Irrigation lines deliver critical nutrients to your crop. Biofilm and scale can clog drippers and irrigation lines, giving inconsistent watering and nutrient delivery. Use **Athena® Renew** between runs to clean your irrigation lines, remove inanimate scale, and prepare the surface for application of disinfectants. For older dirty lines that have been used with organic inputs, you may need to repeat cleaning several times in order to clear all the inanimate organic particulates out of the lines. Follow the step by step procedure to renew your irrigation system with **Athena® Renew** and start clean every time.

Application Rates			
	Normal Cleaning	Heavy Scale /Biofilm	System Sterilization
<b>Renew</b>	8 mL per liter	16 mL per liter	
<b>Reset</b>			8 mL per liter

## Dosing Compatibility

**Athena® Renew** can be dosed into your reservoir with a Dosatron that is compatible with oxidizers. Other dosing systems require special seals such as Viton and Aflas that will allow them to dose acids or oxidizers.

Venturi based systems like Netaflex and Rhythm are not compatible with **Athena® Renew** and should be hand mixed into your reservoir after the injection system. Dosing by hand into your reservoir is the safest way to avoid problems with injection systems.



Athena® Renew



Athena® Reset

## Line Cleaning Procedure:

**WARNING: MAKE SURE TO WEAR PROPER PPE WHEN HANDLING THESE PRODUCTS, INCLUDING GOGGLES, FACE SHIELD WITH RESPIRATOR, COVERALLS WORN OVER LONG-SLEEVED SHIRT AND LONG PANTS, SOCKS, CHEMICAL RESISTANT FOOTWEAR, AND WATERPROOF GLOVES.**

<b>1 Clear</b>	Clear the grow room of all plants.
<b>2 Add</b>	Add <b>Athena® Renew</b> to reservoir with enough water to fully charge the system either by hand or through a doser.
<b>3 Open</b>	Open flush valve at end of drip lines to allow solution to flow through lines but not the drippers.
<b>4 Close</b>	Close lines and turn off the system quickly.
<b>5 Hold</b>	Let the system sit for 12-24 hours.
<b>6 Flush</b>	Open flush valve at end of irrigation lines and flush system of inanimate organic particulate and scale.  <b>NOTE:</b> It is important to do this in a manner to not push particulates into the micro drippers to avoid clogging.
<b>7 Refill</b>	To clear drippers, refill reservoir with a small amount of water and <b>Renew</b> at 8-16 mL per liter.
<b>8 Activate</b>	Activate all emitters and push solution through the system one final time to clean drippers and drip tubes without clogging.
<b>9 Flush</b>	Flush the system with 8 mL per liter of <b>Athena® Reset</b> to sterilize.
<b>10 Flush</b>	Flush the system with clean water.
<b>11 Refill</b>	Refill the system with nutrients and commence fertigation.

Read the entire Directions for Use, Conditions of Warranties, and Limitations of Liability before using this product. If the terms are not acceptable, return the unopened product container at once. By using this product, user or buyer accepts the following Conditions, Disclaimer of Warranties, and Limitations of Liability. **CONDITIONS:** The directions for use of this product are believed to be adequate and must be followed carefully. However, it is impossible to eliminate all risks associated with the use of this product. Crop injury, ineffectiveness, or other unintended consequences may result because of such factors such as weather conditions, presence of other materials, or the manner of use or application, all of which are beyond the control of Athena Ag, Inc. All such risks shall be assumed by the user or buyer. **DISCLAIMER OF WARRANTIES:** To the extent consistent with applicable law, Athena Ag, Inc. makes no other warranties, express or implied, of merchantability or of fitness for a particular purpose or otherwise, that extend beyond the statements made on the product's label. No agent of Athena Ag, Inc. is authorized to make any warranties beyond those contained herein or to modify the warranties contained herein. To the extent consistent with applicable law, Athena Ag, Inc. disclaims any liability whatsoever for special, incidental, or consequential damages resulting from the use or handling of this product. **LIMITATIONS OF LIABILITY:** To the extent consistent with applicable law, the exclusive remedy of the user or buyer for any and all losses, injuries, or damages resulting from the use or handling of this product, whether in contract, warranty, tort, negligence, strict liability or otherwise, shall not exceed the purchase price paid, or at Athena Ag Inc.'s election, the replacement of product.

ATHENA®

CULTURE 



CULTURE 

THE MOST  
**EFFICIENT**  
WAY TO CLONE

Scan code  
for Culture Line  
Procedures



ATHENA®



**VPDome™**

**RACK COVER FOR CLONING**

CLONE	VEG	FLOWER
🔥		

- VPDome™ is the most efficient way to clone.
- Easy-to-install fabric rack cover holds 16 standard clone trays.
- No need for individual tray domes.
- Simple operation streamlines nursery workflow.
- 2-4 hours labor savings per month per rack.
- Uniform and consistent VPD reduces mortality and speeds rooting.
- Durable construction reduces costly plastic dome replacements.
- Anti-microbial coating reduces disease vectors.
- Magnetic door closures click shut and never break.
- Bottom rack cover locks in humidity
- Holders for multiple types of temperature and humidity sensors
- Slots for light bar cables
- Only for use with low-heat LED light bars (no T5)
- 1-year manufacturer warranty

**Cuts**

**ROOTING GEL**

CLONE	VEG	FLOWER
🔥		

- Easy to use
- Unique squeeze tube packaging keep product sterile
- Only use what you need without contaminating or wasting remaining product
- Sticks to stems better than competitors
- Optimal gel consistency
- No pouring or scooping
- Not clumpy/slimy like competitors
- Can be added directly to aerocloner reservoir
- Eco-friendly squeeze-tube uses less packaging
- Non-staining formula

<b>VPDOME</b>	<b>TC-VPD</b>
---------------	---------------

<b>CUTS</b>	7 OZ	<b>LQ-CUTS-7OZ</b>
<b>CUTS</b>	14 OZ	<b>LQ-CUTS-14OZ</b>



## Perfect VPD

Achieving the optimal VPD for plants allows them to properly transpire, uptake nutrients, uptake CO<sub>2</sub>, and prevent stress. VPD stands for Vapor Pressure Deficit, a direct correlation between the temperature and humidity of an area.

Traditional cloning involves using individual domes for each set of clones, essentially creating a microclimate to achieve the higher humidity levels within the dome (lower VPD) to establish roots. This method works great, so long as you maintain consistent air exchange and environmental levels.

VPDome™ helps maintain the perfect VPD throughout the cloning process. Using VPDome™ for large scale cloning requires much less labor than ventilating individual domes every day.

## Establish the Environment

Ensure the environment where the VPDome™ is placed is optimal for clone growth after hardening off. The room should be regulated to a temperature of 70-80°F (21-26 °C) and room humidity at 65-75% to achieve a VPD of about 0.8-1.0 kPa.

Spraying the VPDome™ with a sanitizing agent such as Athena® Reset at 1 oz per gallon (8 mL per L) should be done before every cycle of clones.

### ROOM CLIMATE

**CAUTION: THIS IS THE CLIMATE OUTSIDE OF THE VPDOME. NOT INSIDE THE VPDOME.**

TEMP	HUMIDITY	VPD
70-80°F (21 - 26 °C)	65-75%	0.8-1.0 kPa



**CAUTION: IF NOT FILLING THE VPDOME WITH 16 TRAYS OF CLONES, OPTIMAL ENVIRONMENTAL CONDITIONS WILL NOT BE MET. A SMALL HUMIDIFIER CAN BE PLACED INSIDE TO MAKE UP THAT DIFFERENCE.**

Athena® VPDome™

**WARNING: ONLY USE LED CLONE LIGHTS. NOT COMPATIBLE WITH HEAT-EMITTING LIGHT SUCH AS T5 FLUORESCENT.**

## Procedure

### 1 Fill

Fill the shelving with freshly plugged trays of clones and close the magnetic doors. This is day 1.

**NOTE:** Clones placed on the higher shelves of the VPDome™ would be at an advantage environmentally due to humidity/heat rising.

### 2 Leave

On Day 2, the VPDome™ can be left closed all day to develop the proper humidity levels.

### 3 Ventilate

Day 3 and forward, burping is done for 5 to 20 minutes to ventilate the VPDome™ by leaving the magnetic doors half open with only the lower magnetic strips attached. Research has shown clones remain healthy even when leaving doors open as long as 4 hours.

**NOTE:** Colder environments outside the VPDome™ may create much higher levels of condensation so burping twice a day would be needed.

**NOTE:** Wipe the condensation completely off the doors if there is pest or pathogen pressure within the facility.

### 4 Inspect

The clones should be inspected every day for nutrient health and root development.

**NOTE:** If the clone trays were pre-soaked sufficiently, the clones should be fed again on Days 5, 7, 9, and 11 maintaining a 30-35% dryback.

### 5 Hardening

In days 10-15, the clones should be hardened off so the magnetic doors can be left completely open and strapped back against the sides.

**NOTE:** Before folding the doors into thirds, spray and wipe with a solution of Athena® Reset at 1 oz per gallon (8 mL per L) of water to prevent growth of pathogens.

Read the entire Directions for Use, Conditions of Warranties, and Limitations of Liability before using this product. If the terms are not acceptable, return the unopened product container at once. By using this product, user or buyer accepts the following Conditions, Disclaimer of Warranties, and Limitations of Liability. CONDITIONS: The directions for use of this product are believed to be adequate and must be followed carefully. However, it is impossible to eliminate all risks associated with the use of this product. Crop injury, ineffectiveness, or other unintended consequences may result because of such factors such as weather conditions, presence of other materials, or the manner of use or application, all of which are beyond the control of Athena Ag, Inc. All such risks shall be assumed by the user or buyer. DISCLAIMER OF WARRANTIES: To the extent consistent with applicable law, Athena Ag, Inc. makes no other warranties, express or implied, of merchantability or of fitness for a particular purpose or otherwise, that extend beyond the statements made on the product's label. No agent of Athena Ag, Inc. is authorized to make any warranties beyond those contained herein or to modify the warranties contained herein. To the extent consistent with applicable law, Athena Ag, Inc. disclaims any liability whatsoever for special, incidental, or consequential damages resulting from the use or handling of this product. LIMITATIONS OF LIABILITY: To the extent consistent with applicable law, the exclusive remedy of the user or buyer for any and all losses, injuries, or damages resulting from the use or handling of this product, whether in contract, warranty, tort, negligence, strict liability or otherwise, shall not exceed the purchase price paid, or at Athena Ag Inc.'s election, the replacement of product.





## Athena® Cuts Rooting Gel

Athena® Cuts Rooting Gel is a premium rooting gel formulated to propagate new plants from stem & leaf cuttings of mother plants. It is formulated with an essential plant hormone that promotes rapid root generation and growth.

# CLONING

## STEP-BY-STEP



### WHAT IS CLONING?

The process of replicating genetic phenotypes by taking branch cuttings from mother plants. Branch cuttings contain auxin hormones that encourage lateral root growth.

### WHY CLONE?

To stabilize preferred cultivars in order to produce a consistent final crop on any size scale. Cuttings from the same mother plant share identical chemotype compositions.

#### CLIMATE

TEMP: 23.8° - 26.6° C (Room)  
 RH: 65 - 75% (Room)  
 DH: 80 - 95% (Dome)  
 VPD: 0.8 kPa (Room)  
 PPFD: 100 - 150 (Canopy)  
 EC: 2.0 - 3.0 (Input)  
 PH: 5.6 - 6.0 (Input)

#### LIGHT SCHEDULE

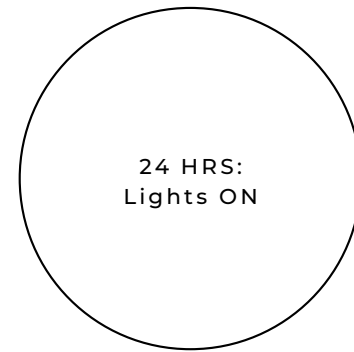

### EXPECTED TIME FRAMES

14 TOTAL DAYS

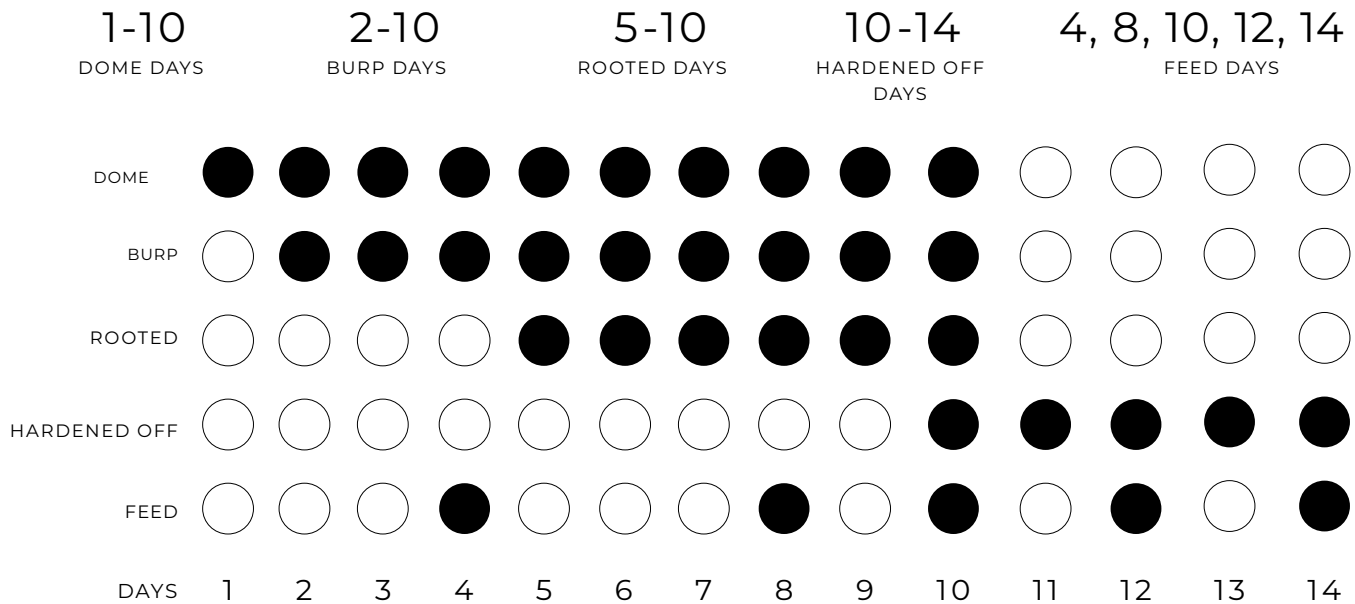

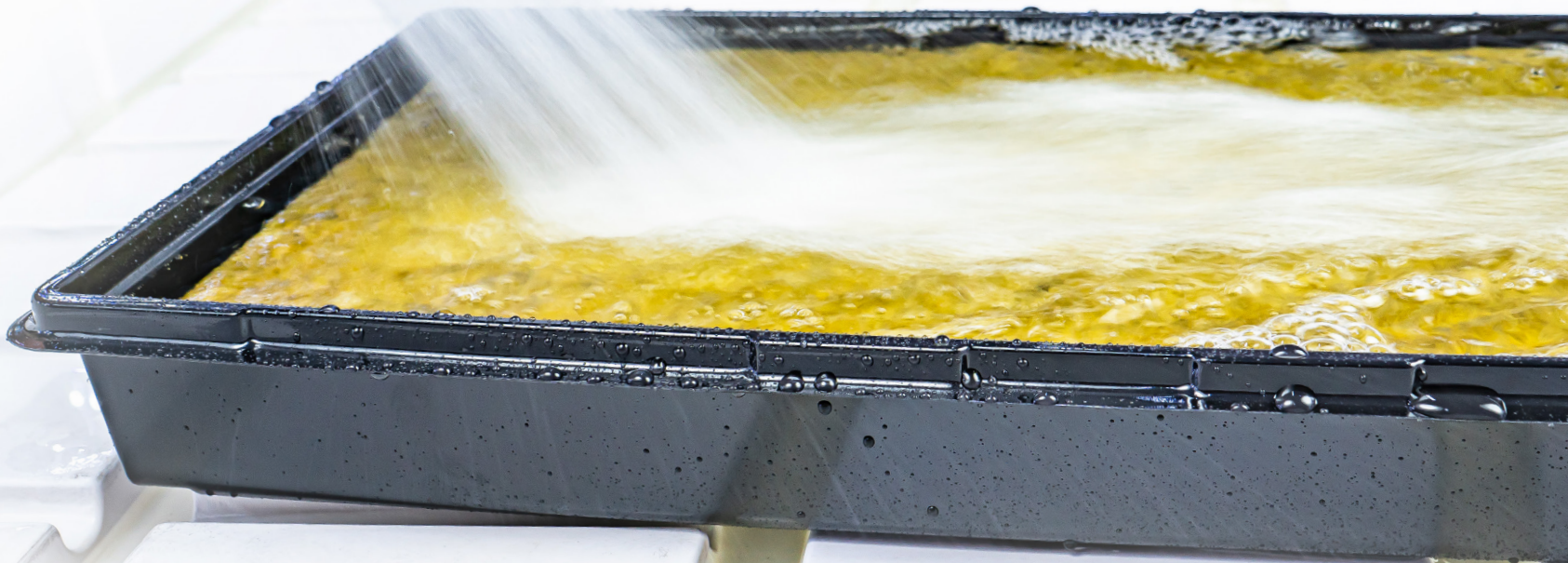

**PRO TIP:**

The solution level should be even with the top of the rockwool slab to ensure complete saturation.

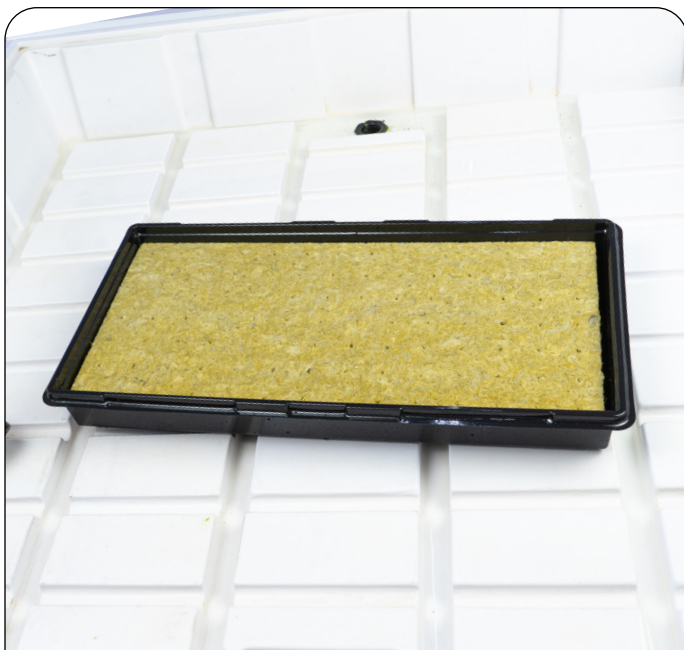

**1** Place a new, dry rockwool slab into a clean base tray.



**2** Saturate the rockwool slab with the Athena® clone feed a recipe.

- 3** Let the rockwool soak for at least 10 minutes.



- 4** Drain excess solution.



- 5** Tilt the tray 90° to drain fully.

**NOTE:** The tray is sufficiently drained when there are only droplets remaining.

In order to encourage a mother plant to produce quality cuttings it is crucial to have proper moisture management through strategic irrigation events and selecting the proper pot size to avoid roots becoming root bound.



**1 Liter**



Day 1-6



Hand feed  
20% run-off



1x every  
2 days

Day 7-14

Hand feed  
20% run-off

1x every  
1-2 days



**4 Liter**



Day 1-7



Hand feed  
20% run-off



1x every  
2 days

Day 8-15

0.5 GPH emitters  
20% run-off

5 min.  
5x daily

Day 16-30

0.5 GPH emitters  
20% run-off

20 min.  
5x daily



**20 Liter**



Day 1-10



Hand feed  
20% run-off



1-2x every  
2 days

Day 11-15

1.0 GPH emitters  
20% run-off

20 min.  
5x daily

Day 16-30

1.0 GPH emitters  
20% run-off

40 min.  
5x daily



**25 Liter**



Day 1-10



Hand feed  
20% run-off



1-2x every  
2 days

Day 11-30

1.0 GPH emitters  
20% run-off

30 min.  
5x daily

Day 31-90

1.0 GPH emitters  
20% run-off

60 min.  
5x daily



- 1 Inspect the Mothers for overall plant health and growth rates.

**NOTE:** Limit cuttings only to mother plants that are at least 60 days old, but no more than 185 days. Older plants tend to become “woodier” and are less likely to maintain optimal plant health or distinct genetic traits.

**PRO TIP:** Do not take any cuttings from mother plants with stunted growth, unhealthy signs of severe nutrient deficiencies, environmental stress, pests or pathogens.



**2** Identify branches to cut, focusing on the upper and middle part of the plant.

**PRO TIP:** Branches should be at least 0.3 cm thick and be more than 15 cm long. Avoid the bent branches on the lower part of the plant.





**PRO TIP:**

Cuttings should be evenly taken from around the entire mother plant to create a balanced and uniform shape.

This technique will produce more primary branches after a three week period of regenerative growth.

- 3 Collect the cuttings in handfuls of 25 to 36 cuttings to bring to the next station.



**1** Measure the stem to be approx. 13 cm tall.



**2** Cut the stem to make the cutting approx. 13 cm tall.



**3** Remove the lower nodes and fan leaves by making cuts flush to the stem.



**4** Hold the top of a cutting by making a fist exposing the blade tips.



**5** Cut off the blade tips.



## CUP THE CUTTINGS

Allocate 25 Cuttings Per Cup

If cuttings are not plugged within 1-2 hours, add more of the Athena® Mother Recipe as needed to maintain the 100-125 mL level in each cup. The bottom 1.5 cm - 4 cm of each cutting stem should always be submerged in the solution until it is plugged to prevent any drying-up and wilting.

1

Place manicured cuttings into a 500 mL cup containing 100-125 mL of the Athena® Mother Recipe (page 49 for [Pro Line](#), page 63 for [Blended Line](#)) onto the cup station.



Each 500 mL cup can safely hold 25 cuts for 1-2 hours in that much solution.



- 1** Use a scalpel to cut through the bottom of the stem at a 45° angle to expose more plant tissue hormones that promote cell division for root growth.



- 2** Dip the 45° angle end of the stem into the shot glass containing the Athena® Cuts rooting compound.

- 3** Coat the bottom 2.5cm of the stem by slowly rotating it in the compound for 5 seconds.



- 4 Delicately stick the 45° angle end of the cutting stem, coated with Athena® Cuts, into the top of the rockwool cube, approximately 2 - 2.5 cm deep.



**NOTE:** Be careful not to break the stem. Do not force the stem into the cube.

2 - 2.5 cm deep



## INSERT TRAY PATTERN

Place the plugged cuttings into the insert tray. To prevent potential canopy problems from overcrowding, use every other insert. A 72 cell insert tray should contain only 36 clones.





- 1** Fill the shelving with freshly plugged trays of clones and close the magnetic doors. This is Day 1.

**NOTE:** If not filling the VPDome<sup>™</sup> with 16 trays of clones, optimal environmental conditions will not be achieved inside the VPDome<sup>™</sup>. A small humidifier placed inside the cover can be used to make up that difference.







**NOTE:** If the clone trays were pre soaked sufficiently, the clones should be fed again on Days 5, 7, 9, and 11 maintaining a 30-35% dryback.



**2** On Day 2, the VPDome™ can be left closed all day to develop the proper humidity levels.





**NOTE:** Before folding the doors into thirds, spray and wipe with a solution of Athena® Reset at 7.8 mL per liter of water to prevent growth of pathogens.



**NOTE:** Colder environments outside the VPDome may create much higher levels of condensation so burping twice a day would be needed.



**3** Day 3 and forward, burping is done for 5 to 20 minutes to ventilate the VPDome™ by leaving the magnetic doors half open with only the lower magnetic strips attached.



CULTURE 

# SAY GOODBYE TO DOMES

SAVE ON TIME, MONEY, AND LABOR.  
NO MORE FLIMSY DOMES THAT BREAK EASILY AND  
CONSTANTLY NEED TO BE REPLACED.

## VPDOME™



LOCATE YOUR NEAREST ATHENA® AUTHORIZED DEALER.

Store and preserve all your cultivars in a very small space. The Athena® Tissue Culture Procedure reinvigorates old genetics and cleans plant material.

# TISSUE CULTURE

## FOR EVERYONE



### KEY FEATURES

- Flow Hood provides a large workspace with face velocity of 0.5 - 0.9 m/s
- Purpose-built Autoclave with one-touch sterilizing operation
- Contains pre-formulated tissue culture media mixes: Roots and Shoots
- Media formulas contain all ingredients, just add water
- Integrated toolbox includes everything you need to do tissue culture
- Integrated step-by-step procedure on how to use the Culture Kit

Scan code  
for Culture Line  
Procedures





**Flow Hood**

- Mobile table-top tissue culture laboratory.
- Large 2.58 cubic ft. clean work zone extends 24 inches in front of HEPA filter.
- Pre-filter G3 & True HEPA H13 filter cleans & purifies active airflow.
- Average face velocity over 0.5-0.9 m/s (industry standard > 0.3 m/s).
- Solid aluminum housing tooled to precision for long-lasting durability.
- Tempered glass door for full work zone visibility.
- Bright LED lighting for proper work zone visibility.
- Built-in, always on dual-outlets to power Autoclave.



**Autoclave**

- Purpose-built from the ground up for simple operation and perfect results every time.
- 8L inner chamber holds full batch of culture media and tools.
- One-touch sterilization - no configuring, just push start.
- Digital display shows sterilization progress.
- One-handed open and close lid operation.
- Gauge shows temperature (F) and pressure (PSI).
- Solid stainless steel construction.
- Safety pressure release valve.
- Manual pressure release valve.



**Roots**  
CULTURE MEDIA

- All-in-one formula: substrate and sugars.
- Just add water and sterilize in Athena® Autoclave.
- For callous formation.
- Used to start new mother plants.
- 10-pack of 125mL included in Culture Kit.



**Shoots**  
CULTURE MEDIA

- All-in-one formula: substrate and sugars.
- Just add water and sterilize in Athena® Autoclave.
- For growth of plant tissue.
- Replicate samples for selection.
- Used for long-term genetic storage.
- Ideal for starting seedling.
- 10-pack of 125mL included in Culture Kit.

CULTURE KIT		TC-KIT
UTILITY VESSEL	25-Pack	TC-UV-25
CULTURE VESSEL	25-Pack	TC-CV-25
GLASSWARE KIT		TC-TOOL
FILTER REPLACEMENT	2-Pack	TC-FILTER

SHOOTS MEDIA	125 ML	TC-CM-ST-125
SHOOTS MEDIA	750 ML	TC-CM-ST-750
ROOTS MEDIA	125 ML	TC-CM-RT-125
ROOTS MEDIA	750 ML	TC-CM-RT-750

CLONE	VEG	FLOWER

\*Not all SKUs are available in all markets. Contact your Dealer/Distributor for product availability based on region.

 ATHENA®

CULTURE 

# 1,000 CULTIVARS

IN YOUR LIBRARY



For The Culture™





# EVERYTHING YOU NEED TO DO TISSUE CULTURE

**Culture Kit™** allows you to store and preserve all your cultivars in a very small space. The Athena® Tissue Culture Procedure reinvigorates old genetics and cleans plant material to outgrow infections like the hop latent viroid (HLV).

**Genetics are the foundation of our culture. Protect them.**

### Toolbox

Provides a large workspace with face velocity of 0.5 - 0.9 m/s.



### Procedure

Full step-by-step instructions on how to use the Culture Kit.

### Flow Hood

Provides a large workspace with face velocity of 0.5 - 0.9 m/s.



### Purpose-built Autoclave

Built from the ground up for simple operation and perfect results every time.

### All-in-one media & nutrition



**Athena® Roots**  
Rooting & Production



**Athena® Shoots**  
Storage & Multiplication



For The Culture™

**Start building your library.**

[AthenaAg.com](https://AthenaAg.com)



## STEP 1: MEDIA PREP

SCAN to watch our Tissue Culture Procedure Video:



**DISCLAIMER:**

- All sterile work is to be done under the workzone unless stated otherwise.
- Always wear gloves and a face covering when working in the workzone.
- Any container with liquid placed in the Autoclave must have a loosely opened lid.
- Spray gloves with alcohol between processes in the workzone.

- 1A.** Pour one pack of 125 mL Shoots or Roots media powder (M) into the 250 mL media vessel.
- 1B.** Pour filtered water (W) into the media vessel up to 125 mL and close the lid.
- 1C.** Agitate the media vessel until the solution is fully dissolved.
- 1D.** Place the desired amount of culture vessels and the media vessel into the Autoclave for a full cycle.
- 1E.** Clean and sterilize the Flow Hood workzone with alcohol wipes (inside and front surfaces).

- 1F.** Place the items from the Autoclave directly under the Flow Hood and allow to cool until roughly 45-54°C (113° - 130°F) or as soon as possible to handle.
- 1G.** Before solution turns to gel, fill each culture vessel ¼ full with media solution (M) and cap.
- 1H.** Let culture vessels settle until the media turns into a gel.
- 1I.** Set culture vessels back into the toolbox of the Flow Hood or in a cool dark place.

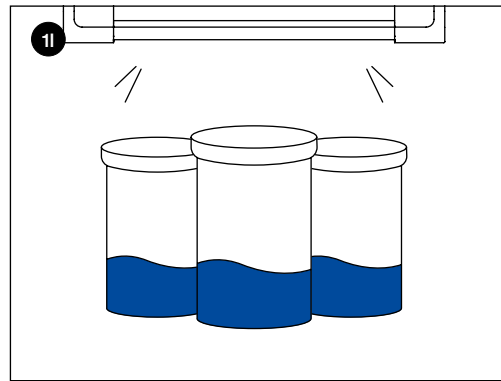
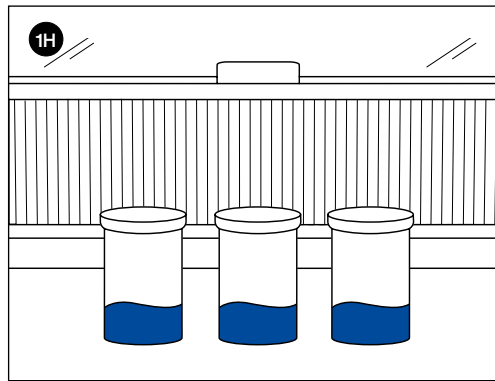
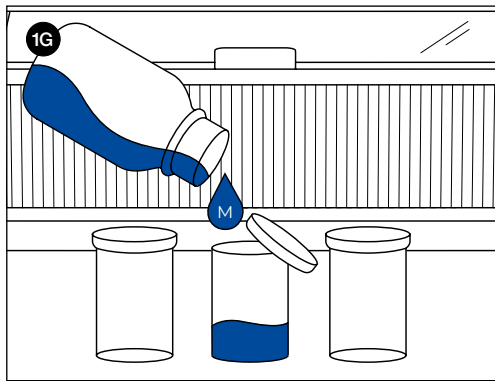
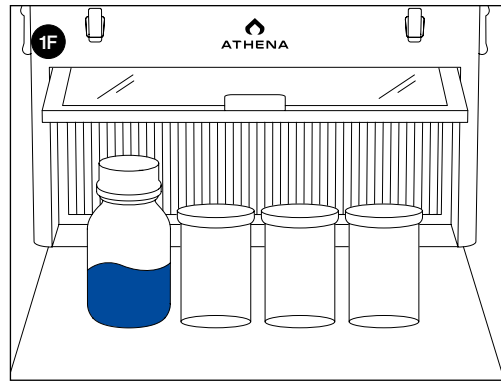
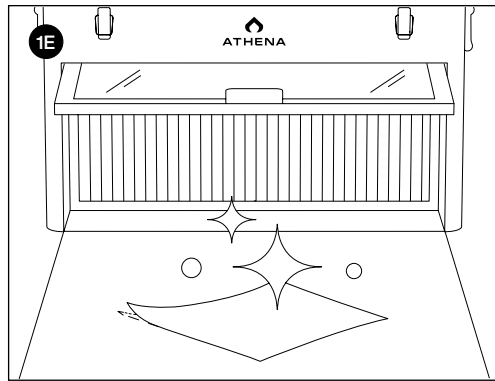
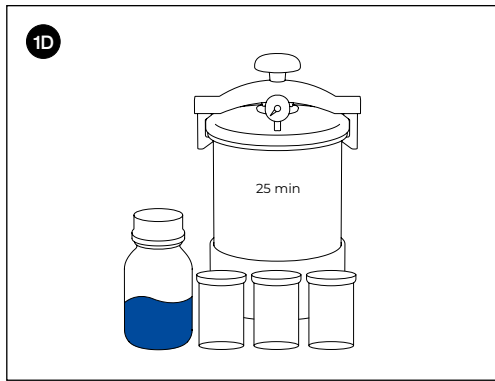
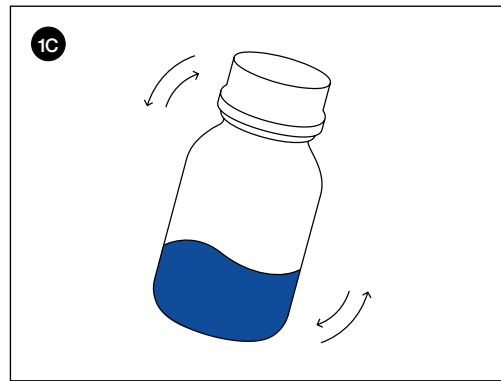
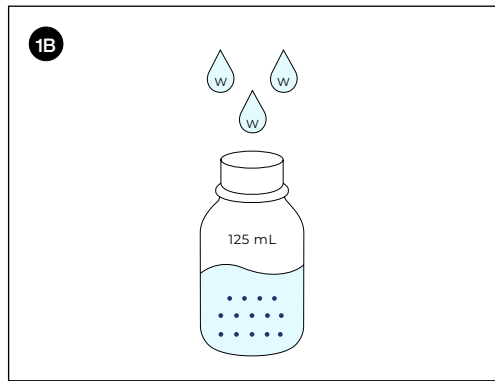
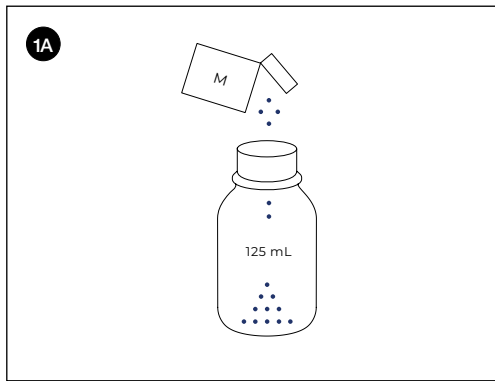

Read the entire Directions for Use, Conditions of Warranties, and Limitations of Liability before using this product. If the terms are not acceptable, return the unopened product container at once. By using this product, user or buyer accepts the following Conditions, Disclaimer of Warranties, and Limitations of Liability. CONDITIONS: The directions for use of this product are believed to be adequate and must be followed carefully. However, it is impossible to eliminate all risks associated with the use of this product. Crop injury, ineffectiveness, or other unintended consequences may result because of such factors such as weather conditions, presence of other materials, or the manner of use or application, all of which are beyond the control of Athena Ag, Inc. All such risks shall be assumed by the user or buyer. DISCLAIMER OF WARRANTIES: To the extent consistent with applicable law, Athena Ag, Inc. makes no other warranties, express or implied, of merchantability or of fitness for a particular purpose or otherwise, that extend beyond the statements made on the product's label. No agent of Athena Ag, Inc. is authorized to make any warranties beyond those contained herein or to modify the warranties contained herein. To the extent consistent with applicable law, Athena Ag, Inc. disclaims any liability whatsoever for special, incidental, or consequential damages resulting from the use or handling of this product. LIMITATIONS OF LIABILITY: To the extent consistent with applicable law, the exclusive remedy of the user or buyer for any and all losses, injuries, or damages resulting from the use or handling of this product, whether in contract, warranty, tort, negligence, strict liability or otherwise, shall not exceed the purchase price paid, or at Athena Ag Inc.'s election, the replacement of product.

Follow us on Instagram!





# TISSUE CULTURE PROCEDURE

CULTURE

## STEP 2: PLANT PREP

SCAN to watch our Tissue Culture Procedure Video:

**DISCLAIMER:**

- All sterile work is to be done under the workzone unless stated otherwise.
- Always wear gloves and a face covering when working in the workzone.
- Any container with liquid placed in the Autoclave must have a loosely opened lid.
- Spray gloves with alcohol between processes in the workzone.

- 2A.** Place an apical cut taken from clean, healthy moms on a sterilized **work surface** in the **workzone** and remove the leaf material with a sterilized **scalpel**. **Note:** These can be uppers, lowers or middles. Healthier material will yield best results.
- 2B.** Dissect the cutting at the middle of each internode leaving enough stem under each node to go into the media.
- 2C.** Place all the nodes into a sterilized **utility vessel** and fill it with 240 mL (8 oz) of filtered water (W).
- 2D.** Wrap the **forceps**, **scalpel**, **paper towel**, and **work surface** in aluminum and gather (2) **utility vessels** each filled with 240 mL (8 oz) of filtered water to place into the **Autoclave** for a full cycle.
- 2E.** Clean and sterilize the **workzone** with alcohol wipes (inside and front surfaces).
- 2F.** Place the items from the **Autoclave** into the **workzone** along with the

sterilized **utility vessel** filled with nodes.

- 2G.** Add 0.5 mL of **Cleanse (C)** and agitate the mixture for 15 secs.
- 2H.** Slightly open the lid to pour the **Cleanse (C)** solution into a waste container without dropping nodes. **Note:** The waste container is held outside of the **workzone**.
- 2I.** Use the **utility vessel** from the **Autoclave** to refill the **utility vessel** containing the nodes with 240 mL (8 oz) of water, add 20 mL of **Bleach (B)**, agitate the mixture, and leave for 10 min in the **workzone**.
- 2J.** Slightly open the lid to pour the **Bleach (B)** solution into a waste container without dropping nodes. **Note:** The waste container is held outside of the **workzone**.
- 2K.** Use the **utility vessel** from the **Autoclave** to refill the **utility vessel** containing the nodes with 240 mL (8 oz) of water (W).
- 2L.** Agitate the **utility vessel** and pour out the water into a waste container as a final rinse.

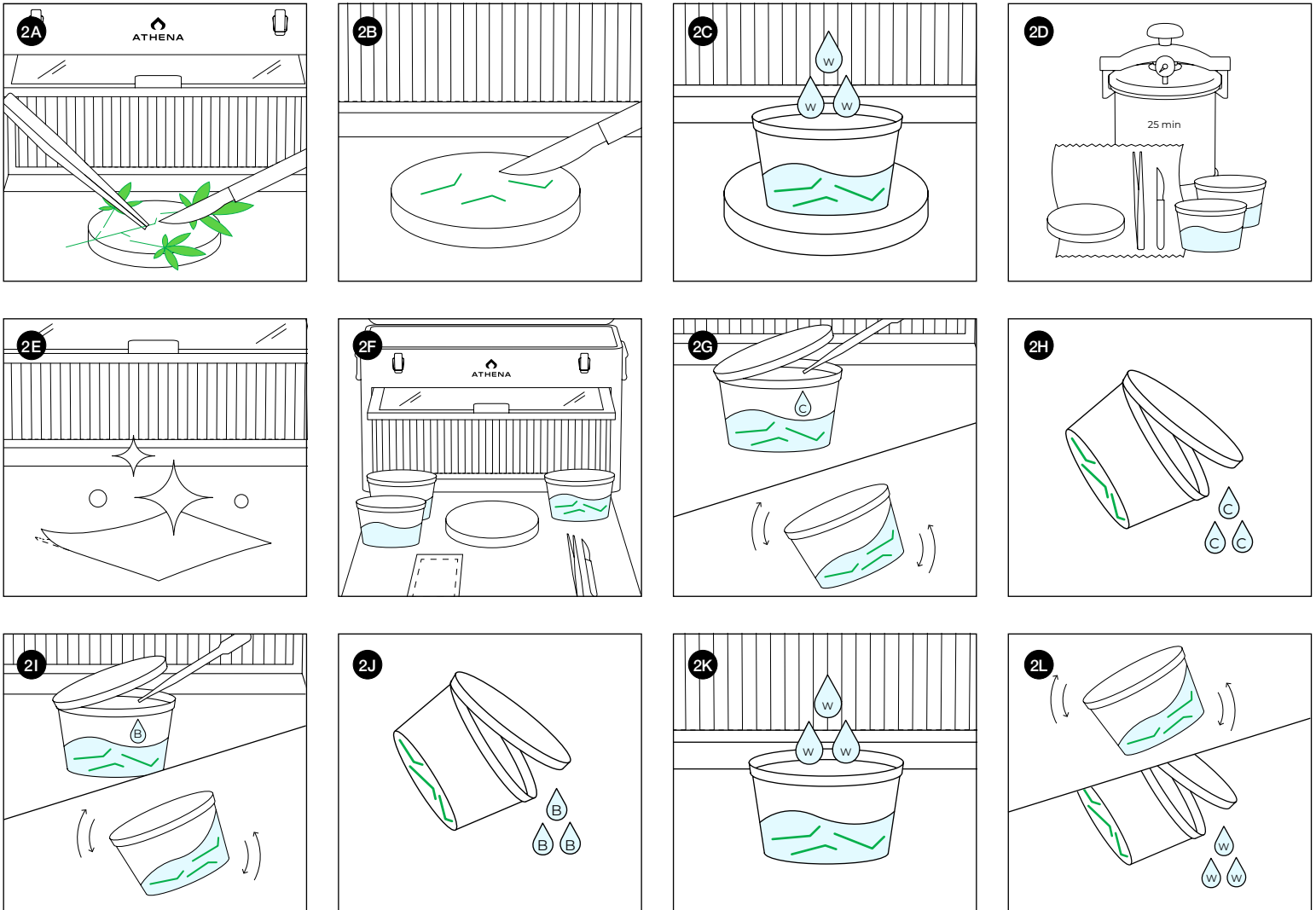

Read the entire Directions for Use, Conditions of Warranties, and Limitations of Liability before using this product. If the terms are not acceptable, return the unopened product container at once. By using this product, user or buyer accepts the following Conditions, Disclaimer of Warranties, and Limitations of Liability. CONDITIONS: The directions for use of this product are believed to be adequate and must be followed carefully. However, it is impossible to eliminate all risks associated with the use of this product. Crop injury, ineffectiveness, or other unintended consequences may result because of such factors such as weather conditions, presence of other materials, or the manner of use or application, all of which are beyond the control of Athena Ag, Inc. All such risks shall be assumed by the user or buyer. DISCLAIMER OF WARRANTIES: To the extent consistent with applicable law, Athena Ag, Inc. makes no other warranties, express or implied, of merchantability or of fitness for a particular purpose or otherwise, that extend beyond the statements made on the product's label. No agent of Athena Ag, Inc. is authorized to make any warranties beyond those contained herein or to modify the warranties contained herein. To the extent consistent with applicable law, Athena Ag, Inc. disclaims any liability whatsoever for special, incidental, or consequential damages resulting from the use or handling of this product. LIMITATIONS OF LIABILITY: To the extent consistent with applicable law, the exclusive remedy of the user or buyer for any and all losses, injuries, or damages resulting from the use or handling of this product, whether in contract, warranty, tort, negligence, strict liability or otherwise, shall not exceed the purchase price paid, or at Athena Ag Inc.'s election, the replacement of product.

Follow us on Instagram!

@Athena.Ag

A01.002

AthenaAg.com

ATHENA®



# TISSUE CULTURE PROCEDURE



## STEP 3: LAB PREP

SCAN to watch our Tissue Culture Procedure Video:

**DISCLAIMER:**

- All sterile work is to be done under the workzone unless stated otherwise.
- Always wear gloves and a face covering when working in the workzone.
- Any container with liquid placed in the Autoclave must have a loosely opened lid.
- Spray gloves with alcohol between processes in the workzone.

- 3A. Clean and sterilize the **workzone** with alcohol wipes (inside and front surfaces).
- 3B. Spray alcohol to sterilize the culture vessels with **Shoots media** and the **alcohol burner** before placing them into the **workzone**.
- 3C. Slightly open the **utility vessel** with cuttings, remove one node with sterilized **forceps**, and place it on the sterile **work surface**.
- 3D. While holding the node steady with **forceps**, dissect it at the lower end, leaving

- enough stem to go into media.
- 3E. Slightly open the **culture vessel** and place the node's exposed tissue into the media and close the cap right away. This is now an explant. **Note:** Ensure that the tools do not touch media or **culture vessels**.
- 3F. Sterilize the **forceps** and scalpel blade with the **alcohol burner** after each cutting.
- 3G. Spray the **work surface** with alcohol after each cutting. **Note:** Repeat steps D-G for each explant you want to create.
- 3H. When all **culture vessels** are prepared with newly made explants, store them under a clone light at 75-125 PPFD and room temperature of 20-25.5°C (68 - 78°F).

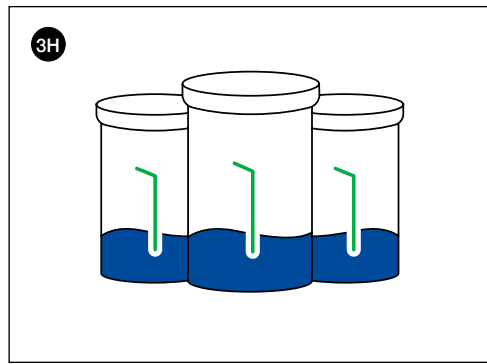
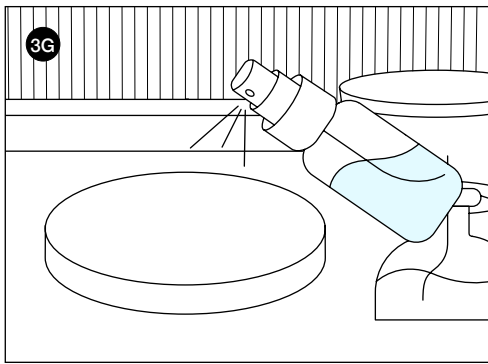
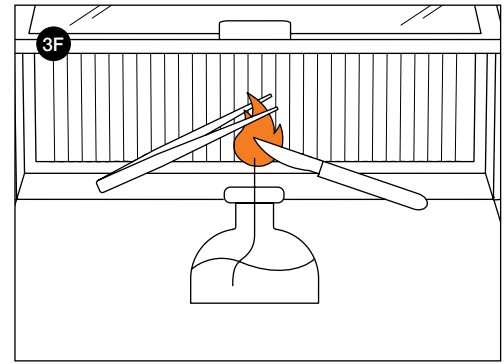
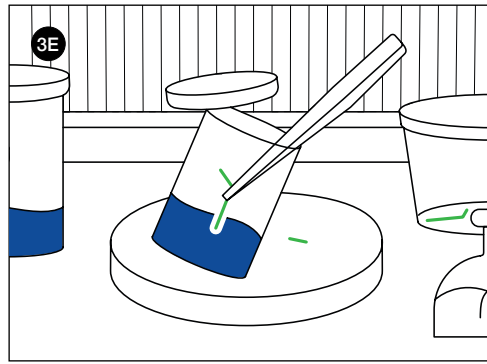
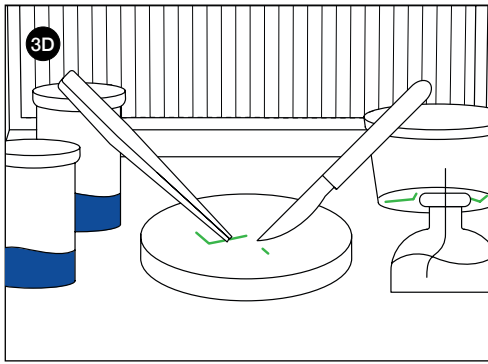
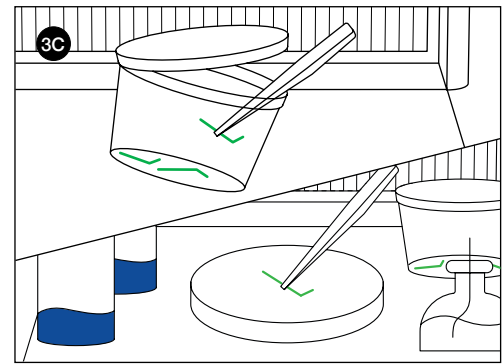
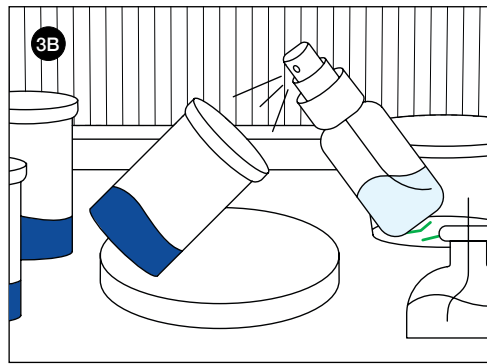
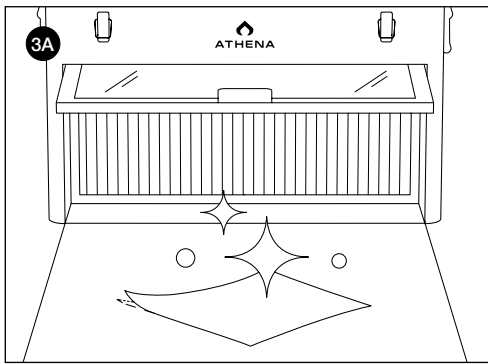

Read the entire Directions for Use, Conditions of Warranties, and Limitations of Liability before using this product. If the terms are not acceptable, return the unopened product container at once. By using this product, user or buyer accepts the following Conditions, Disclaimer of Warranties, and Limitations of Liability. CONDITIONS: The directions for use of this product are believed to be adequate and must be followed carefully. However, it is impossible to eliminate all risks associated with the use of this product. Crop injury, ineffectiveness, or other unintended consequences may result because of such factors such as weather conditions, presence of other materials, or the manner of use or application, all of which are beyond the control of Athena Ag, Inc. All such risks shall be assumed by the user or buyer. DISCLAIMER OF WARRANTIES: To the extent consistent with applicable law, Athena Ag, Inc. makes no other warranties, express or implied, of merchantability or of fitness for a particular purpose or otherwise, that extend beyond the statements made on the product's label. No agent of Athena Ag, Inc. is authorized to make any warranties beyond those contained herein or to modify the warranties contained herein. To the extent consistent with applicable law, Athena Ag, Inc. disclaims any liability whatsoever for special, incidental, or consequential damages resulting from the use or handling of this product. LIMITATIONS OF LIABILITY: To the extent consistent with applicable law, the exclusive remedy of the user or buyer for any and all losses, injuries, or damages resulting from the use or handling of this product, whether in contract, warranty, tort, negligence, strict liability or otherwise, shall not exceed the purchase price paid, or at Athena Ag Inc's election, the replacement of product.

Follow us on Instagram!



## STEP 4: TRANSFER

SCAN to watch our Tissue Culture Procedure Video:

**⚠️ DISCLAIMER:**

- All sterile work is to be done under the workzone unless stated otherwise.
- Always wear gloves and a face covering when working in the workzone.
- Any container with liquid placed in the Autoclave must have a loosely opened lid.
- Spray gloves with alcohol between processes in the workzone.

- 4A. Wrap the **forceps**, **scalpel**, **work surface**, and **paper towel** in aluminum foil to place in the **Autoclave** for a full cycle.
- 4B. Clean and sterilize the **Flow Hood workzone** with alcohol wipes (inside and front surfaces).
- 4C. Use the alcohol sprayer to sterilize all **culture vessels** filled with **Roots/ Shoots** formula, the vessels with explants, and the **alcohol burner** before placing them into the **workzone**.
- 4D. Place the items from the **Autoclave** directly under the **Flow Hood**.
- 4E. Remove an explant showing prominent new growth from the **Shoots culture vessels** and place it on the **work surface**.  
**Note:** Ensure that the tools do not touch the media or **culture vessels**.
- 4F. Dissect the explant at the middle of each internode leaving enough stem under each node to go into the media.
- 4G. If the goal is to preserve the genetic material: Place the cutting into a **culture vessel** with **Shoots** media.
- 4H. If the goal is to create a mother plant: Place the cutting into a **culture vessel** with **Roots** media.
- 4I. Sterilize the **forceps** and **scalpel** blade with the alcohol burner after each cutting.
- 4J. Spray the work surface with alcohol after each cutting.  
**Note:** Repeat steps 4E-4J for each explant dissected.
- 4K. When all **culture vessels** are prepared with newly made explants, store them under a clone light at 75-125 PPFD and 20-25.5°C (68-78°F) room temperature.

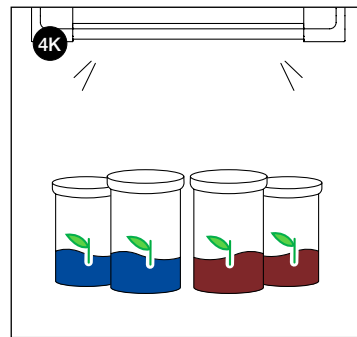
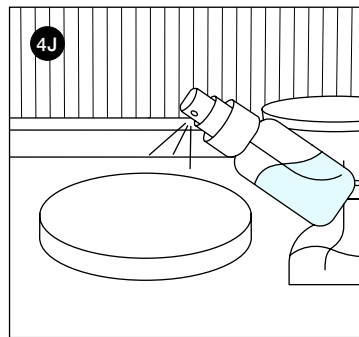
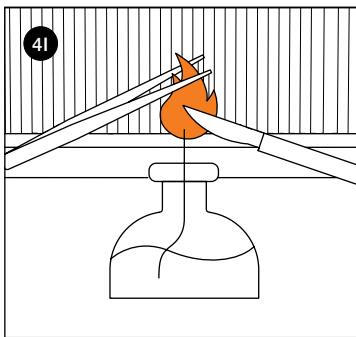
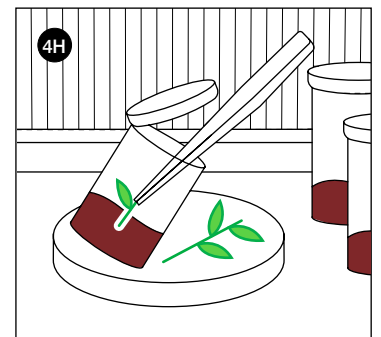
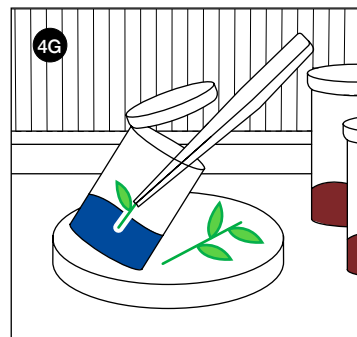
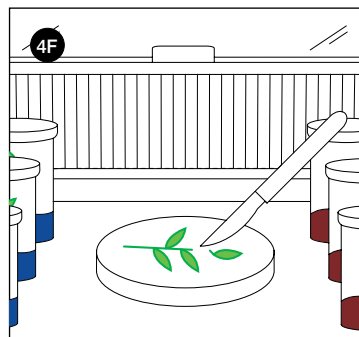
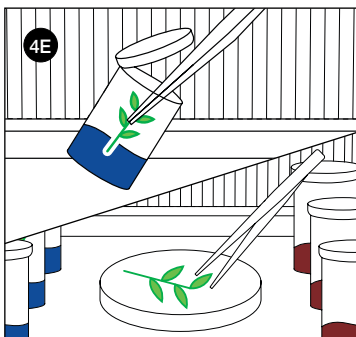
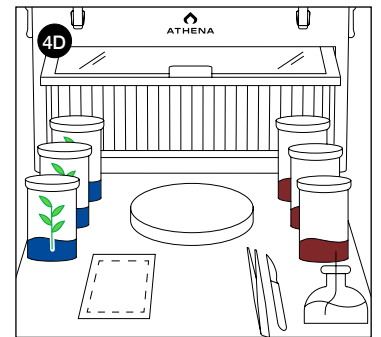
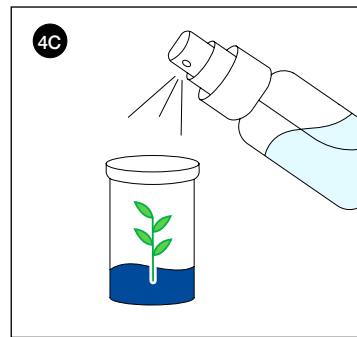
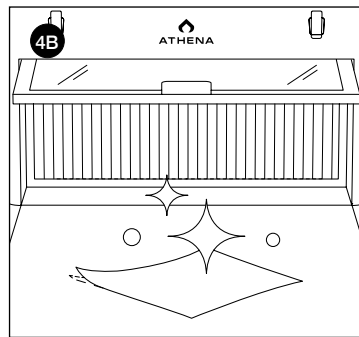
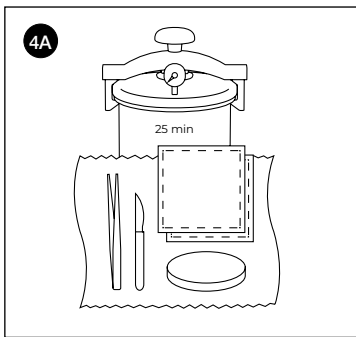

Read the entire Directions for Use, Conditions of Warranties, and Limitations of Liability before using this product. If the terms are not acceptable, return the unopened product container at once. By using this product, user or buyer accepts the following Conditions, Disclaimer of Warranties, and Limitations of Liability. CONDITIONS: The directions for use of this product are believed to be adequate and must be followed carefully. However, it is impossible to eliminate all risks associated with the use of this product. Crop injury, ineffectiveness, or other unintended consequences may result because of such factors such as weather conditions, presence of other materials, or the manner of use or application, all of which are beyond the control of Athena Ag, Inc. All such risks shall be assumed by the user or buyer. DISCLAIMER OF WARRANTIES: To the extent consistent with applicable law, Athena Ag, Inc. makes no other warranties, express or implied, of merchantability or of fitness for a particular purpose or otherwise, that extend beyond the statements made on the product's label. No agent of Athena Ag, Inc. is authorized to make any warranties beyond those contained herein or to modify the warranties contained herein. To the extent consistent with applicable law, Athena Ag, Inc. disclaims any liability whatsoever for special, incidental, or consequential damages resulting from the use or handling of this product. LIMITATIONS OF LIABILITY: To the extent consistent with applicable law, the exclusive remedy of the user or buyer for any and all losses, injuries, or damages resulting from the use or handling of this product, whether in contract, warranty, tort, negligence, strict liability or otherwise, shall not exceed the purchase price paid, or at Athena Ag Inc.'s election, the replacement of product.

Follow us on Instagram!

@Athena.Ag

A01.002

AthenaAg.com

ATHENA®

# LIGHTING ENVIRONMENT

In order to ensure optimal light levels, we recommend checking the light intensity around the room at canopy height with an ePAR meter. The Apogee MQ-610 ePAR is recommended.



**MQ-610**

400-750 nm ePAR Meter



**DLI-600**

ePAR, Daily Light Integral, and Photoperiod Meter (ePAR, 400-750 nm)

**CONTACT:**  
 (435) 792-4700  
 ApogeeInstruments.com



An efficient lighting schedule is crucial to maximizing yields, and getting the most out of each watt driving the room. It starts with selecting a light source that works best for the grow. Two of the best options for a grow room light are HID (high intensity discharge) 1000w DE (double ended) fixtures, and LED fixtures.

### TERMS TO KNOW:

It is important to understand these terms to achieve optimal light levels. Different cannabis strains have their own optimal lighting needs, just like they have their own optimal environment.

**ePAR:** (extended photosynthetically active radiation) is a widely used generic term that refers to photons that drive photosynthesis with wavelengths between 400nm - 750nm on the electromagnetic spectrum.

**ePPF:** (extended photosynthetic photon flux; micromoles per second) is the total photon output of a fixture in the ePAR range.

**ePPFD:** (extended photosynthetic photon flux density; micromoles per meter<sup>2</sup> per second) is defined as the number of photons within the ePAR range from a fixture, per unit area (m<sup>2</sup>). Quantum meters measure ePPFD because we only want to measure the amount of light energy that makes it to the canopy, not the total amount of light energy that the fixture puts out. Higher photon flux to the canopy equals bigger yields.

**eDLI:** (extended daily light integral; μmoles per m<sup>2</sup> per day) measures the same parameters as ePPFD, but integrates this over one day (24 hours). These two metrics are directly related and you can convert between the two.

**ePPFD to eDLI - ePPFD** (μmol m<sup>-2</sup> s<sup>-1</sup>) × **3600** (seconds in an hour) × **12** (photoperiod) ÷ **1,000,000** (μmol to mol)

**eDLI to ePPFD - eDLI** (mol m<sup>-2</sup> d<sup>-1</sup>) × **1,000,000** (μmol to mol) ÷ **12** (photoperiod) ÷ **3600** (seconds in an hour)

**Example: Veg - 600 (ePPFD) x 3600 x 12 ÷ 1,000,000 = 25.92 eDLI**

OPTIMAL LIGHT LEVELS (for most strains)					
CLONE		VEG		FLOWER	
ePPFD	75 - 150	ePPFD	300 - 1000	ePPFD	800 - 1200
eDLI	3.2 - 6.5	eDLI	26 - 43	eDLI	35 - 69

1000w DE fixtures need to have sufficient space between the fixtures widthwise, so that the light overlap does not create hot spots. In places where the light overlaps it multiplies the intensity, so the center of the rooms will always have a higher intensity than the edges of the rooms (FIG. 2). In rooms with a lower light count (less than 30) 1.22 m x 1.5 m works well (FIG. 1) due to throwing light in a bow tie shape (FIG. 3). In rooms with a higher light count that spacing can be too intense so increasing the footprint to 1.22 m x 1.83 m works better.

## HPS ROOM 11 m x 5.5 m

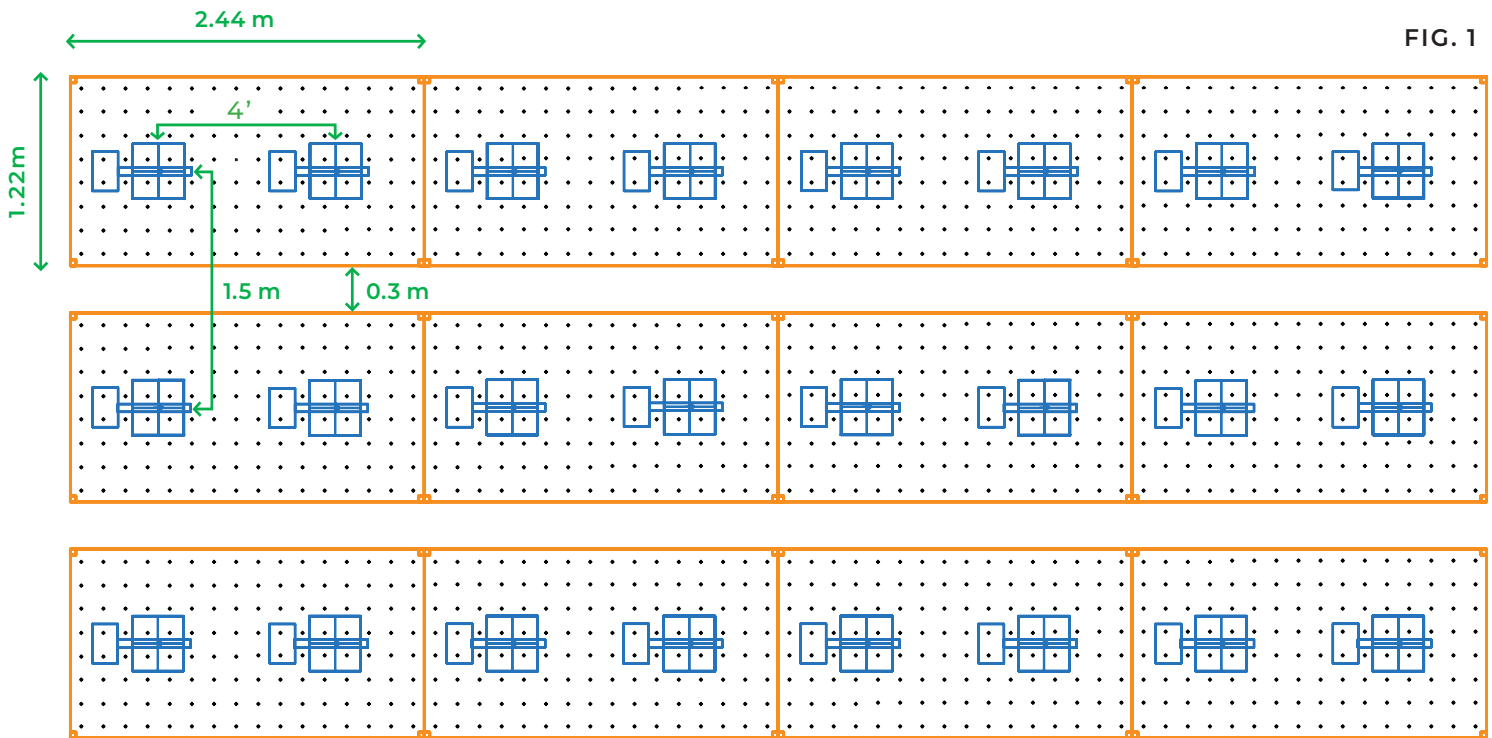

FIG. 1

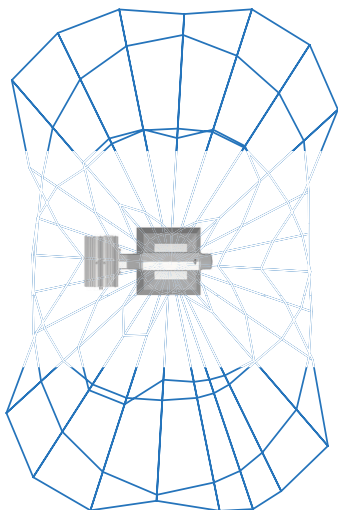

FIG. 3

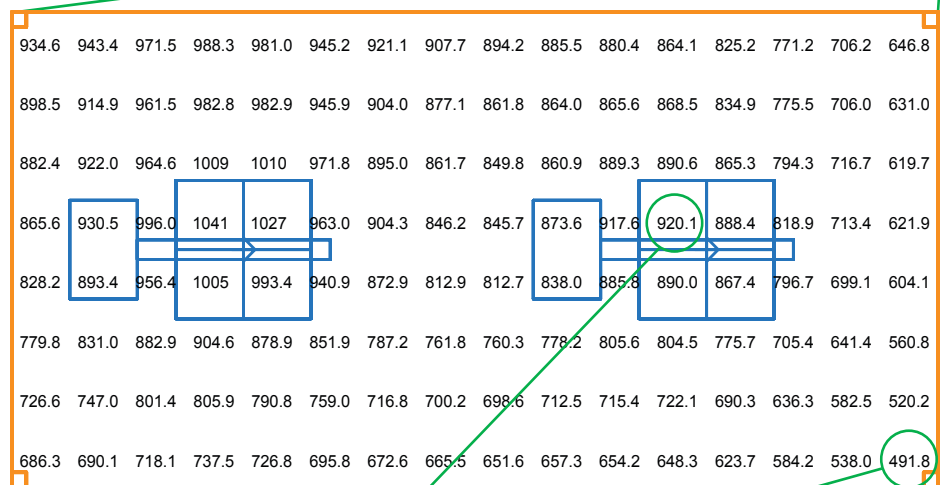

FIG. 2

920

491

# LED LAYOUT



Proper spacing with 650w LED's can be achieved by placing the fixtures on center over the canopy covering a 1.22 m x 1.22 m area (FIG. 4), because they do such a great job of throwing light in a very uniform pattern (FIG. 6). Despite this uniformity, due to light overlap, there will still be higher intensity in the center of the room and lower intensity around the edges (FIG. 5). LED fixtures can be dimmed very easily, so the distance to canopy is not as vital with LED's because if the light is too intense at a set distance, the fixture can be dimmed to achieve the desired light level.

**LED ROOM**  
11 m x 5.5 m



1.22 m x 2.44 m  
Bench

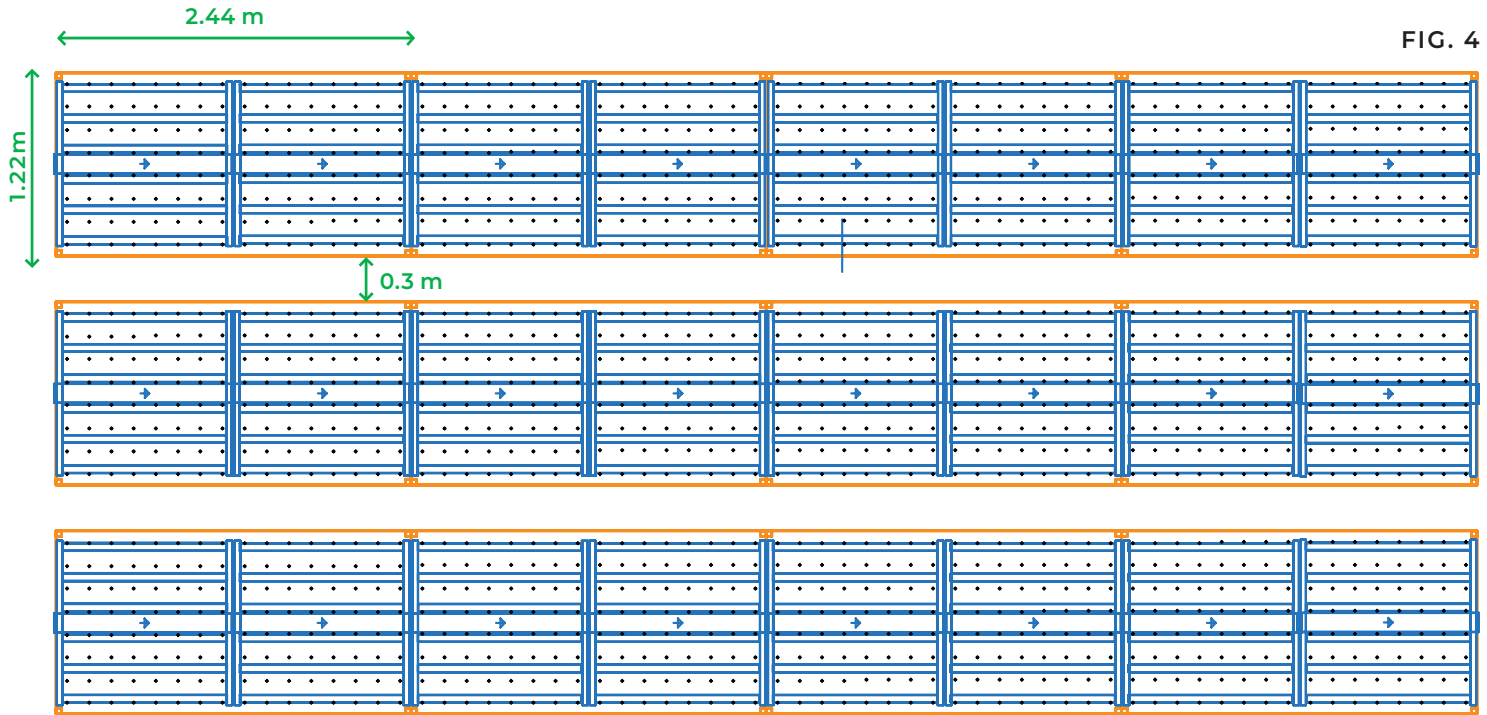

FIG. 4

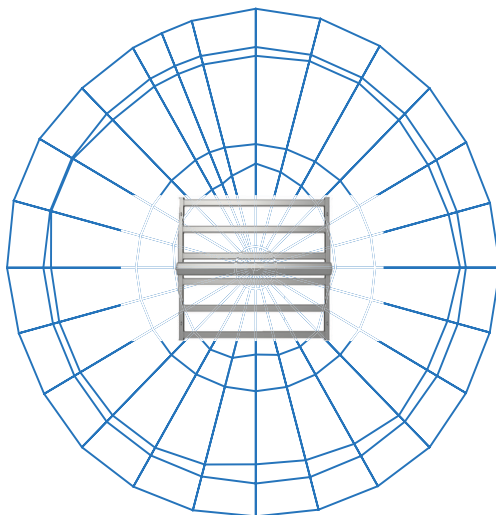

FIG. 6

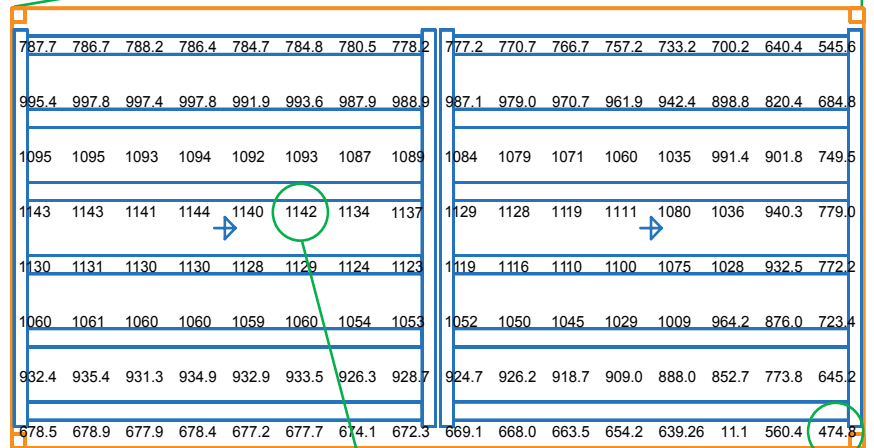

FIG. 5

1142

474



Climate control is critical for indoor cannabis grow rooms because it directly affects the growth and overall health of the plants. Cannabis plants require specific temperature, humidity, and air circulation levels to thrive, and any deviation from these optimal conditions can result in stunted growth, disease, and even death. For example, high humidity levels can encourage the growth of mold and mildew, while low humidity can lead to dehydration and wilting of the plants. Additionally, temperature fluctuations can affect the potency and yield of the final product. Therefore, it is crucial for growers to closely monitor and control the climate in their indoor grow rooms to ensure the best possible outcome for their cannabis plants. This can be achieved through the use of various climate control tools such as air



TISSUE CULTURE	
<b>CLIMATE</b>	<b>LIGHT SCHEDULE</b>
<p>TEMP: 20° - 23° C (Room)</p> <p>RH: 50 - 60% (Room)</p> <p>VPD: 0.8 - 1.0 kPa (Room)</p> <p>PPFD: 75 - 125 (Canopy)</p>	



CLONES	
<b>CLIMATE</b>	<b>LIGHT SCHEDULE</b>
<p>TEMP: 23° - 26° C (Room)</p> <p>RH: 65 - 75% (Room)</p> <p>DH: 80 - 95% (Dome)</p> <p>VPD: 0.8 kPa (Room)</p> <p>PPFD: 100 - 150 (Canopy)</p> <p>EC: 2.0 - 3.0 (Input)</p> <p>PH: 5.6 - 6.0 (Input)</p>	



VEG	
<b>CLIMATE</b>	<b>LIGHT SCHEDULE</b>
<p>TEMP: 22° - 28° C (Room)</p> <p>RH: 58 - 75% (Room)</p> <p>VPD: 0.8 - 1.0 kPa (Room)</p> <p>PPFD: 300 - 600 (Canopy)</p> <p>EC: 3.0 (Input)</p> <p>PH: 5.6 - 6.0 (Input)</p>	



<b>FLOWER – STRETCH</b>		Week 1 - Week 3
 <b>CLIMATE</b>	<p>● <b>LIGHT SCHEDULE</b></p> 	
TEMP:	25° - 28° C	(Room)
RH:	60 - 72%	(Room)
VPD:	1.0 - 1.2 kPa	(Room)
PPFD:	600 - 1000	(Canopy)
EC:	3.0	(Input)
PH:	5.8 - 6.2	(Input)
C02:	1200-1500	(Canopy)

<b>FLOWER – BULK</b>		Week 4 - Week 7
 <b>CLIMATE</b>	<p>● <b>LIGHT SCHEDULE</b></p> 	
TEMP:	24° - 26° C	(Room)
RH:	60 - 70%	(Room)
VPD:	1.0 - 1.2 kPa	(Room)
PPFD:	850 - 1200	(Canopy)
EC:	3.0	(Input)
PH:	6.0 - 6.2	(Input)
C02:	1200-1500	(Canopy)

<b>FLOWER – FINISH</b>		Week 8 - Week 9
 <b>CLIMATE</b>	<p>● <b>LIGHT SCHEDULE</b></p> 	
TEMP:	18° - 24° C	(Room)
RH:	50 - 60%	(Room)
VPD:	1.2 - 1.4 kPa	(Room)
PPFD:	600 - 900	(Canopy)
EC:	2.0 - 3.0	(Input)
PH:	6.0 - 6.2	(Input)
C02:	500-800	(Canopy)

<b>DRY &amp; CURE</b>		Dry Time: 14 Days
 <b>CLIMATE</b>	<p>● <b>LIGHT SCHEDULE</b></p> 	
TEMP:	15° - 18° C	(Room)
RH:	55 - 60%	(Room)

**FACILITY** 

# Drip Irrigation

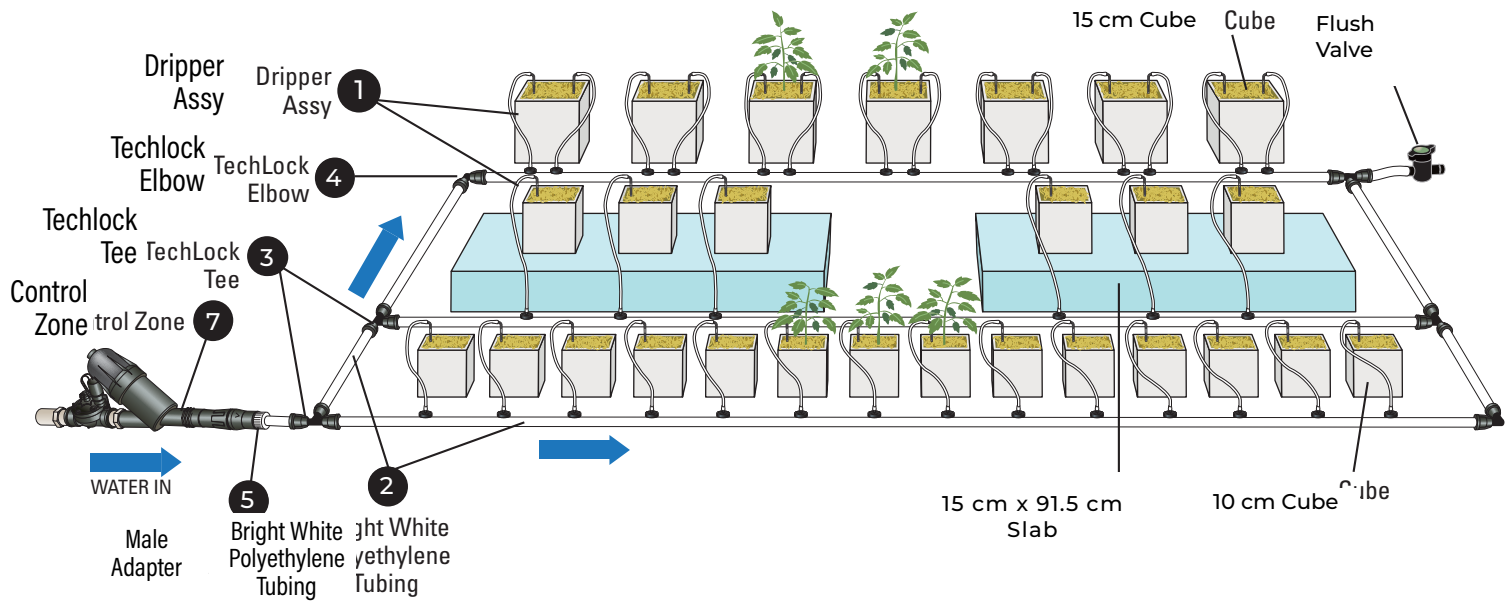

## Precision Rockwool/Coco Applications

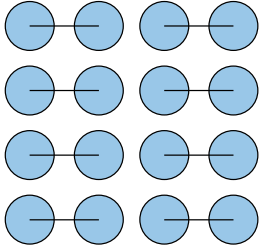
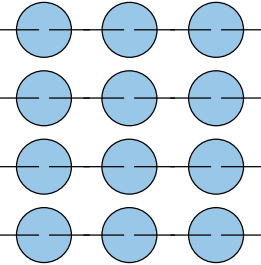
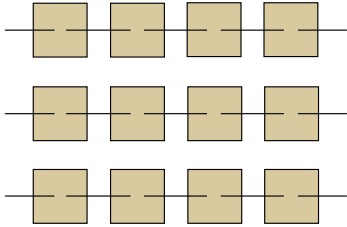
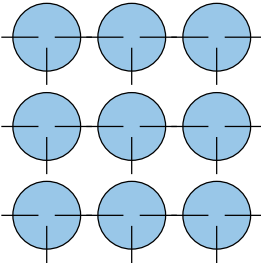
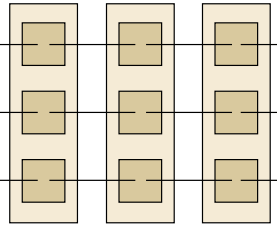
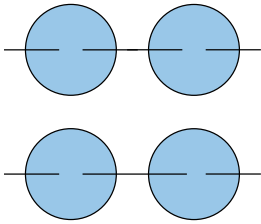
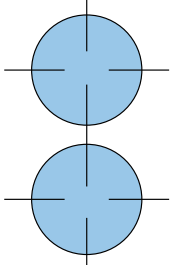
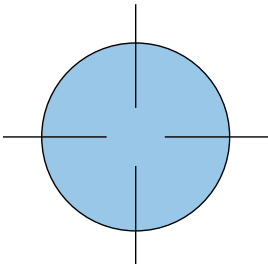

ORDERING INFORMATION			
KEY	MODEL NUMBER	DESCRIPTION	QUANTITY NEEDED
1	01WPCJL1.2AW-30	1200 ML/HR DRIPPER STAKE ASSEMBLY, 25 PER BUNDLE	1 PER 10 CM AND SMALLER CUBES 2 PER 15 CM AND LARGER CUBES 3 PER 91.5 CM LONG SLAB
2	14BW056066-05	17 MM BRIGHT WHITE UV POLYETHYLENE TUBING 152.4 M ROLL	EITHER 1 RUN PER ROW OF PLANTS OR 1 RUN DOWN THE CENTER OF EVERY 2 ROWS OF PLANTS DOWN THE TABLE/TRAY
3	TLCKTEE	17MM TECHLOCK TEE (25 PER BAG)	AS NEEDED
4	TLCKELL	17MM TECHLOCK ELBOW (25 PER BAG)	AS NEEDED
5	TLCK075MA	19MM MPT X 17MM TECHLOCK MALE ADAPTER (25 PER BAG)	AS NEEDED
6	58ISV600	17MM BARBED LINE FLUSH VALVE (25 PER BAG)	1 AT THE END OF EVERY PE LINE OR AT THE END OF A TABLE MANIFOLDED TOGETHER AS SHOW IN DIAGRAM ABOVE
7	LVCZS8010075-LF	CONTROL ZONE: ZONE VALVE, FILTER, PRESSURE REGULATOR PRE-ASSEMBLED, 1 PER ZONE UP TO 4.4 GPM	1 CAN BE USED FOR UP TO 800 OF THE 1200 ML/HR DRIPPERS

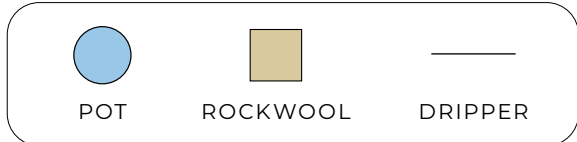
	Plants	Pot Size	Canopy Footprint 1.2mx1.2m or 1.5mx1.5m	Netafim Pressure Compensating Drippers	Rockwool Size	
	INDOOR or GREENHOUSE	16	2-4 L		(1) 1.2 LPH	10 cm
10-14		5-6 L		(2) 1.2 LPH	15 cm	
6-9		7-10 L		(2) 2 LPH or (3)* 1.2 LPH	<i>Thumper Base</i> 10cm cube on 7.3x14.6x91.4 slab  *Only (2) .3 drippers in slab setup	
OUTDOOR or MOTHERS	3-5	10 L		(2) 2 LPH or (4) 1.2 LPH	<b>PLANT SPACING</b>  This is a baseline recommendation. It may be necessary to try different layouts to find the ideal layout for your facility. The goal is finding the right of amount of airflow and number of plants within your available space. The smaller the dripper, the easier it is to control your root zone. Bigger pots need more drippers to properly hydrate the substrate. We recommend 5-7 gallon pots to be used for outdoor flowering and large mother plants.	
	2	20 L		(4) 2 LPH		
	1	26-40 L		(4) 2 LPH		



Follow us on Instagram!  
 @Athena.Ag 

For more information regarding the Athena® Program, please visit our website:  
**AthenaAg.com** A01.001  
Athena® Handbook | 117

EC: mS/cm <sup>2</sup>	PPM: 500	PPM: 700
0.5	250	350
0.6	300	420
0.7	350	490
0.8	400	560
0.9	450	700
1.0	500	770
1.1	550	840
1.2	600	910
1.4	650	980
1.5	700	1050
1.6	750	1120
1.7	800	1190
1.8	850	1260
1.9	900	1330
2.0	950	1400
2.1	1000	1470
2.2	1050	1540
2.3	1100	1610
2.4	1150	1680
2.5	1200	1750
2.6	1250	1820
2.7	1300	1890
2.8	1350	1960
2.9	1400	2030
30	1500	2100

# We the Growers

A Growers podcast hosted by a panel of growers based out of Southern California. We bring you perspective, best practices and discuss the latest technology in the Cannabis Industry. Our guest are knowledgeable sharing years of Cultivation experience throughout a multitude of trades within the Cannabis Industry.

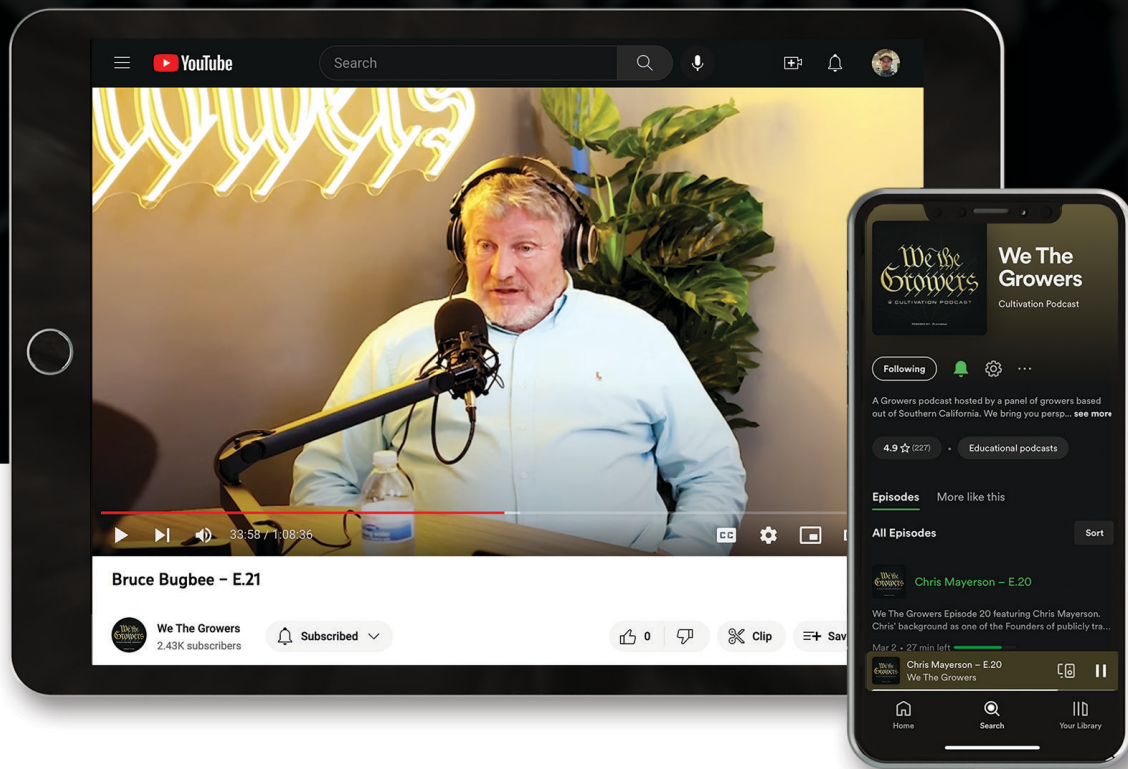

## LISTEN FOR:

- BEST PRACTICES
- LATEST TECHNOLOGY
- INDUSTRY EXPERIENCE

## AVAILABLE NOW ON:



**DEMETER**  
DESIGNS

TAKE

**CONTROL** OF YOUR  
**IRRIGATION**

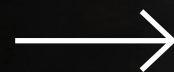

RENDERING  
SUCCESS



## AN IRRIGATION SYSTEM THAT ADAPTS TO YOU



3D Facility  
Modeling

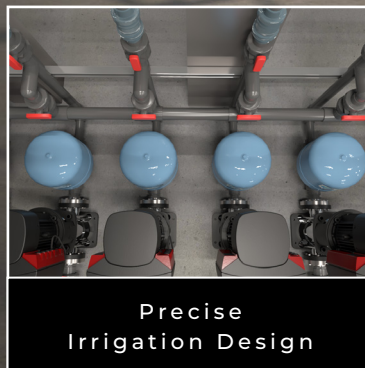

Precise  
Irrigation Design

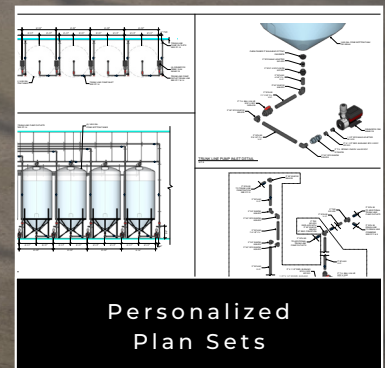

Personalized  
Plan Sets

## ABOUT DEMETER

Demeter Designs provides superior fertigation and irrigation plan sets and renderings proven to maximize efficiency when building out the heart of your facility.

Our team consists of growers with decades of experience in cannabis cultivation whose background is building and operating advanced cultivation facilities. While the continuous progression of automation systems may seem complex, our detailed plans provide the building blocks required for anyone to install a state of the art fertigation system anywhere in the world.

📍 @DemeterDesigns.ag

🌐 DemeterDesigns.ag





EACH PERSONALIZED PLAN SET INCLUDES

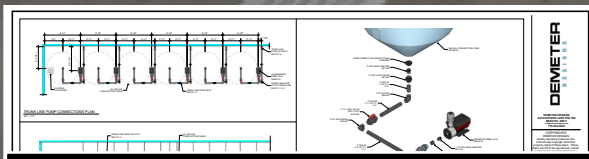

**Construction Documents**  
 (with floorplans, elevations, exploded assembly details and 3D perspective views)

**DEMETER DESIGNS**

SAMPLE PARTS LIST

1	1000	1000
2	2000	2000
3	3000	3000
4	4000	4000
5	5000	5000
6	6000	6000
7	7000	7000
8	8000	8000
9	9000	9000
10	10000	10000

11	11000	11000
12	12000	12000
13	13000	13000
14	14000	14000
15	15000	15000
16	16000	16000
17	17000	17000
18	18000	18000
19	19000	19000
20	20000	20000

**Complete Parts List**

**GRUNDFOS**

Description	Value
General information:	
Product name:	CRNE 10-6 N-FGJ-AE-HQGE
Product No.:	96392059
EAN:	5713828369659
Technical:	
Rated pump speed:	3461 rpm

**Equipment Spec Sheets**



**Photorealistic 3D Renderings**

**SCAN CODE**

TO BRING YOUR FACILITY TO LIFE





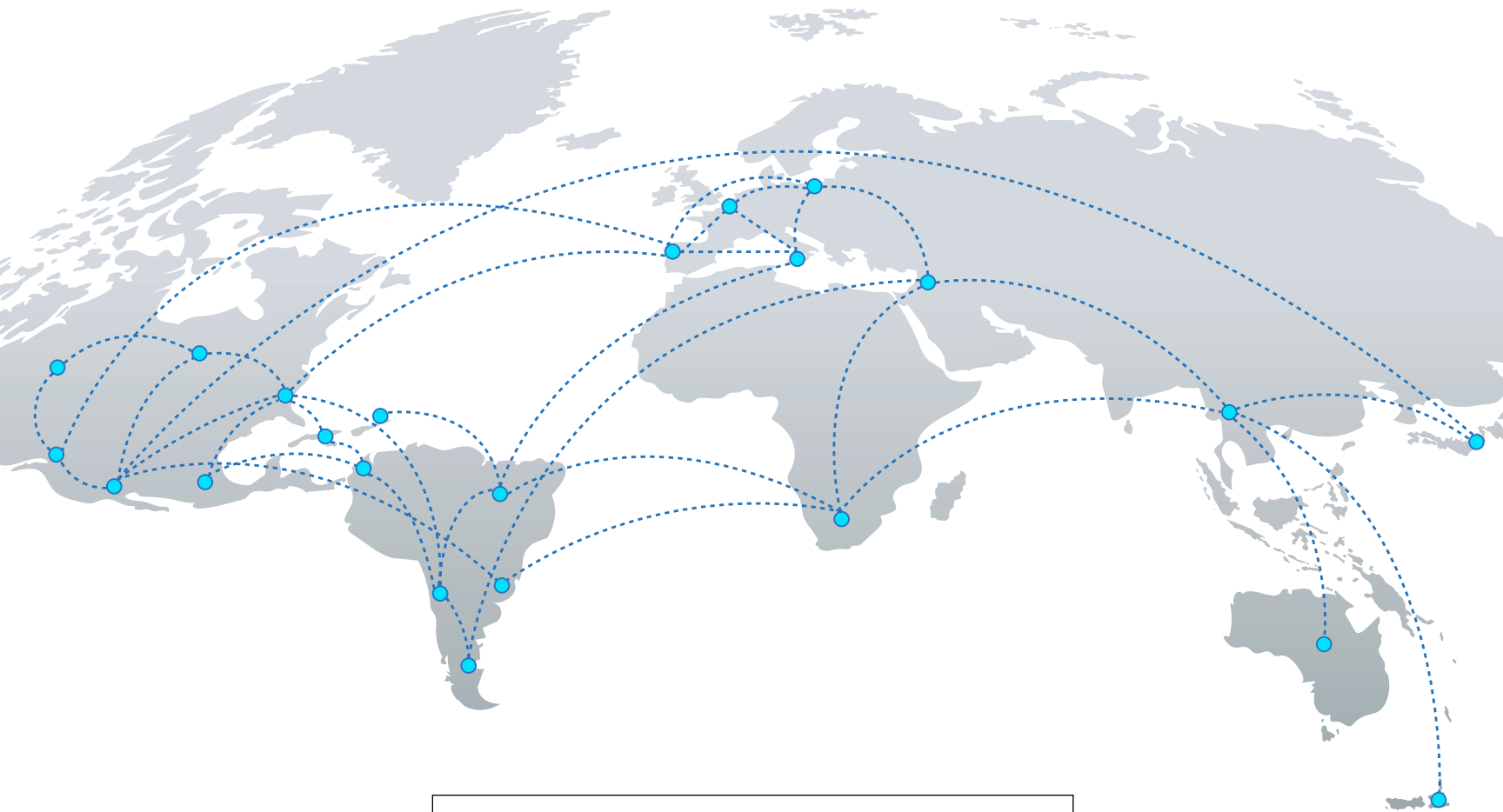



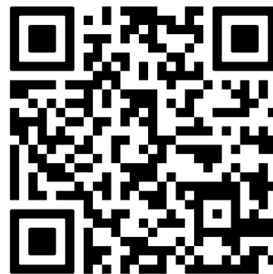

# GLOBAL DISTRIBUTION NETWORK



**SCAN**

TO LOCATE  
YOUR NEAREST  
AUTHORIZED  
DEALER.



<p> ATHENA®</p> <p>Call</p>  <p>1.844.333.1818</p>	<p> ATHENA®</p> <p>Visit</p>  <p>AthenaAg.com</p>	
<p> ATHENA®</p> <p>Instagram</p> <p>facebook</p> 	<p> YouTube</p> 	<p><i>We the Growers</i></p> <p> YouTube</p> 









Product availability may vary by market.  
Contact Athena® or your local distributor for availability.



SKU: ATH-HNDBK-MET